

INTERNATIONAL HARVESTER
TITAN
OIL ENGINES

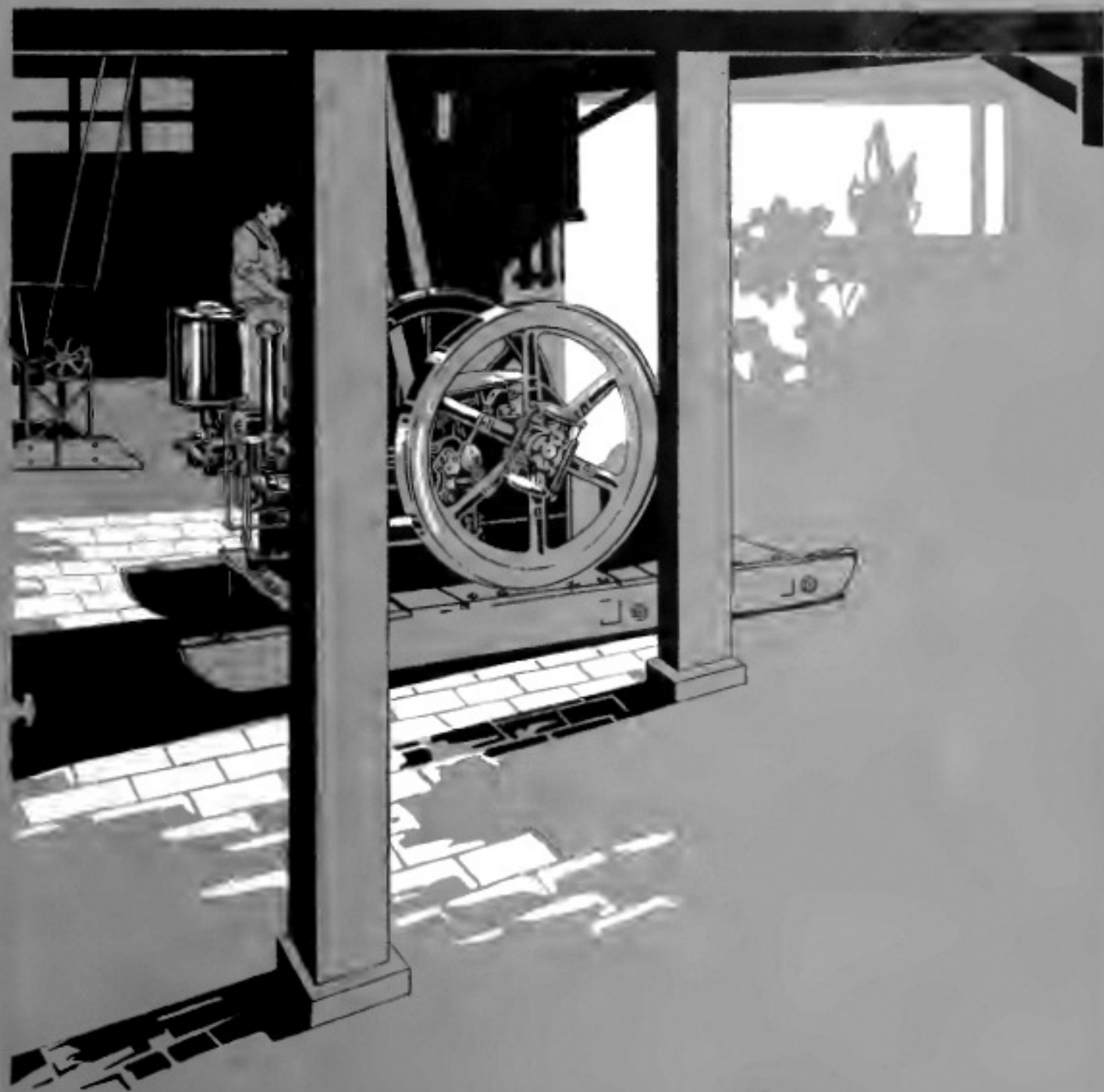

Titan Oil Engines--30 Types, 15 Sizes The Greatest Variety of Engines Built



Vertical Skidded, Page 10



Vertical Stationary, Page 11



Pumping, Page 24



Nonpareil, Page 11



1-H. P., Page 8



2 1/2-H. P., Page 9



Nonpareil, Page 10



Air-Cooled, Page 8

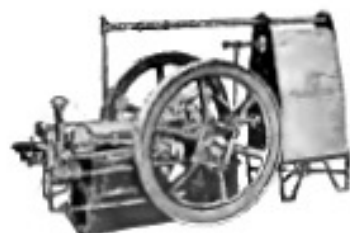

T. C. Stationary, Page 14



T. C. Skidded, Page 12



H. C. Skidded, Page 13

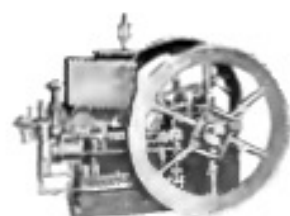

H. C. Stationary, Page 15



T. C. Portable, Page 16

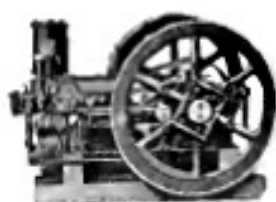

T. C. Mounting, Page 18

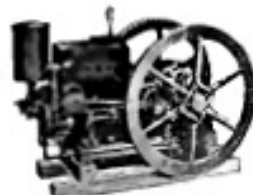

H. C. Mounting, Page 18



H. C. Portable, Page 17

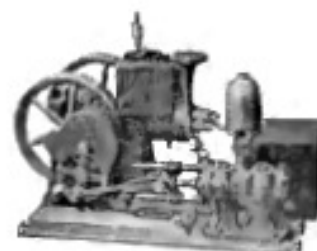

Pumping, Page 25

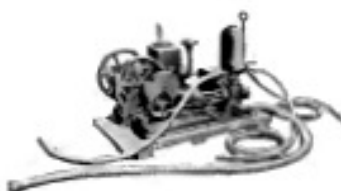

Spraying, Page 27



Sawing, Page 23

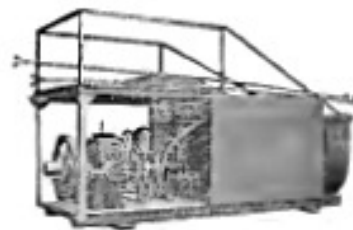

Spraying, Page 27

INTERNATIONAL HARVESTER COMPANY OF AMERICA

(INCORPORATED)

The Factory That Has Built a Quarter of a Million Oil and Gas Engines

Experience Tells The novice makes a poor farmer at first, and his product is of an inferior quality until he has had experience. The same is true in manufacturing, only more so, as the manufacturer has not nature to help him. The International Harvester Works at Milwaukee have been manufacturing engines for ten years. They have built over 250,000 engines during this time—more than any other manufacturer. They have been shipped to all parts of the world and used under the most variable conditions of service. Every year the product has been improved as experience has shown where it could be bettered even if only slightly. This means that every part of a Titan engine that could possibly break or get out of order must have done so in the vast quantity of engines already built and have come to the attention of the Company. The Titan you buy today protects you against the ordinary engine ills—it is a result of long experience—a product you can depend upon.

Automatic Machinery Means Standardization No matter how well a machine is designed if it is not well made it will not be a success. It

takes good machinery to produce well finished parts and automatic machinery to produce accurate parts. The International Harvester Works at Milwaukee are a model for equipment. The very latest automatic machines make Titan parts. They make every similar part exactly alike without the slightest variation so that if a new part is needed, it will fit as good as the old one. Not only does automatic machinery make parts better but it makes them cheaper. This is the reason you get so much more with a Titan engine for your money.

Titan Inspection Means Perfection After an engine is finished in the Titan plant, it goes through a long siege of testing. Every part is carefully adjusted and it is subjected to a severe test run which is sure to bring out any faults in the construction or material. This is done before the paint is put on so nothing is covered up. It is one more protection you have in a Titan engine. This engine is as good as experience, the best machinery, the best materials and the most careful inspection can make it. No guarantee could be stronger than the name "Titan". It represents all that is good in an oil engine.

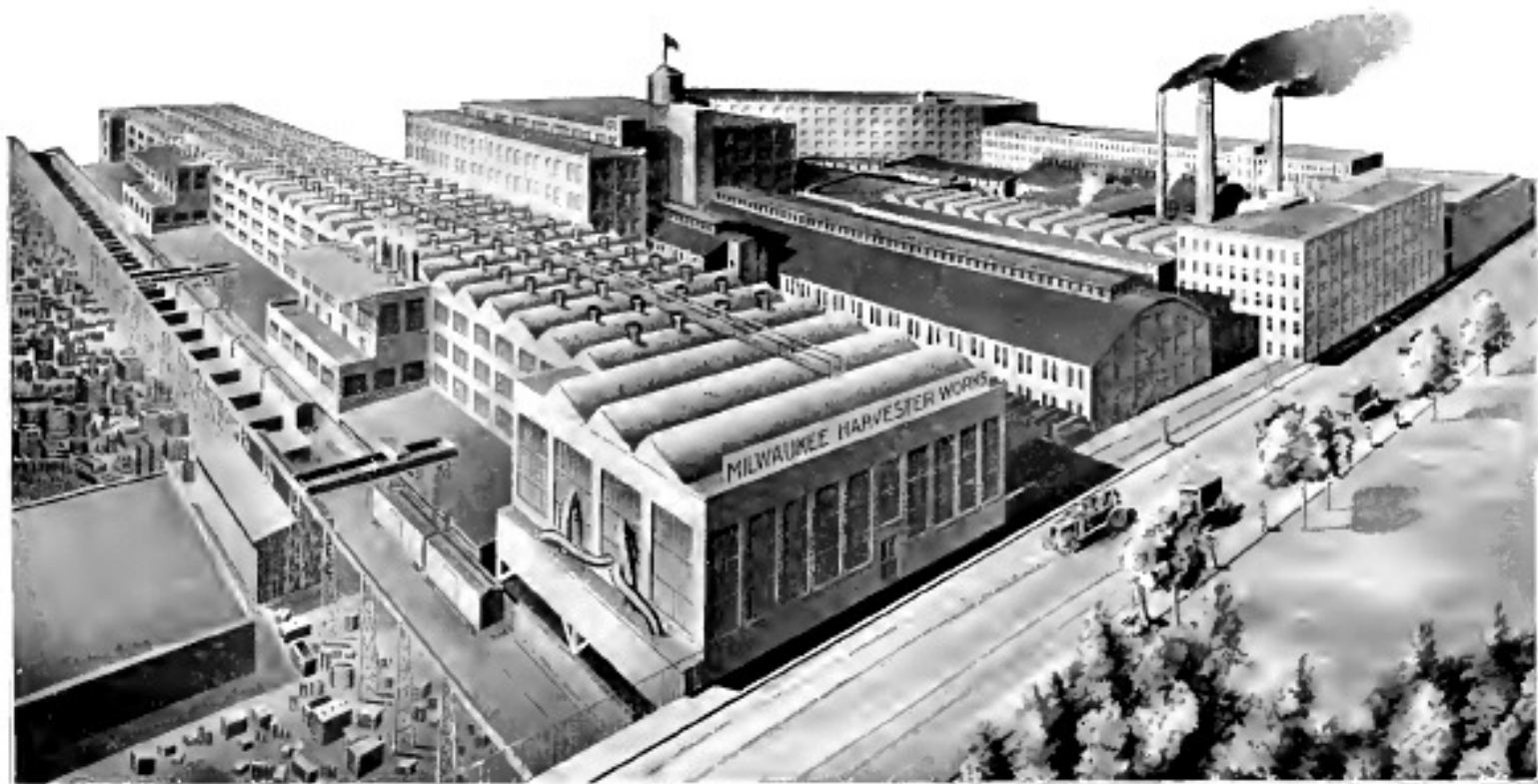

Milwaukee Works at Milwaukee, Wis.—The Home of the Titan Engines

Repairs Can Be Obtained Almost Anywhere

The Value of Service—the kind the International Harvester Company of America gives through its eighty-seven branch houses and thirty-five thousand dealers should not be lost sight of in the purchase of an engine. In many localities it is of vital importance to the engine owner and should be considered of equal importance to the quality of the engine.

International Harvester Service The International Harvester branches are conveniently located to give the best service to the surrounding territory, and there is no place so small or out of the way that cannot be reached from one or more of the many branches. Suppose your engine should freeze up some cold night or through some accident a part would be broken just at the time when you needed power most, it would only be a matter of a day or two at most till the new part could be obtained from the nearest branch house. More than likely the International Harvester dealer in your own or neighboring town would

have the part in stock waiting for just such an occasion. Time means money and the loss of several days or sometimes weeks in delay waiting for parts or advice, especially when you have a gang of men drawing pay for doing nothing, means enough money to nearly pay for the engine. At least the annoyance caused due to the wait is worth considering. But International Harvester service means more than quick repairs. It means that you have expert farm machine men within easy reach whom you can call on for advice and instructions for installing and operating machinery by engine power. Often you can get personal attention as International Harvester men are traveling everywhere.

Service a Guarantee International Harvester service is a protection against loss of time and a convenience that you get with the purchase of every Titan engine without extra cost. It is an asset that cannot be duplicated in any other make of engine or farm machine. Be sure and get a genuine Titan—it bears the IHC trade mark.



Eighty-seven branch houses in all parts of the United States to give you prompt service

The younger generation welcomes a Titan to do chores



A Titan gives you the convenience of city water



Tools can be quickly sharpened



A Titan beats the buck saw



Titan power is not variable like the wind

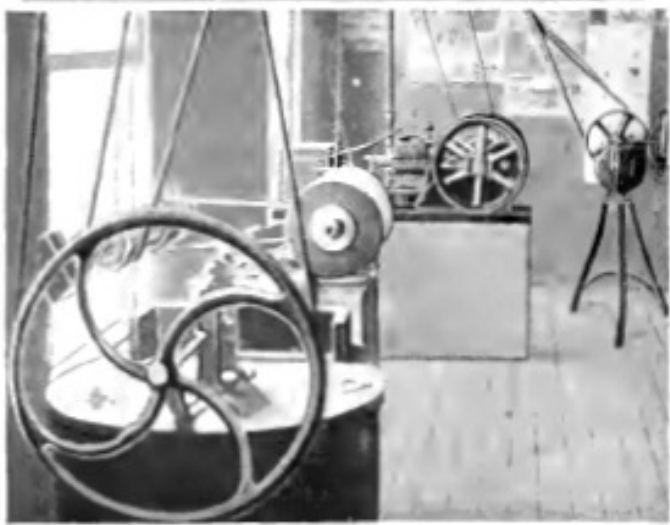

"Tom Thumb" is the best shop helper



"Tom Thumb" saws the kindling

A Titan does the hardest part of the Womans work

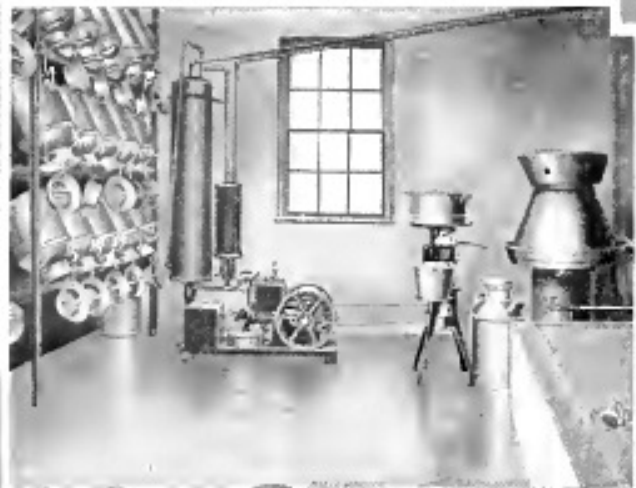

The best way to run a separator

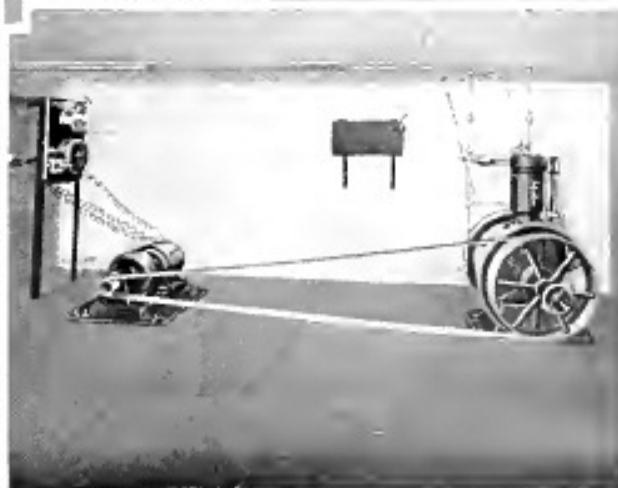

Safe, sanitary light



The busy butter maker



Power for the dairy

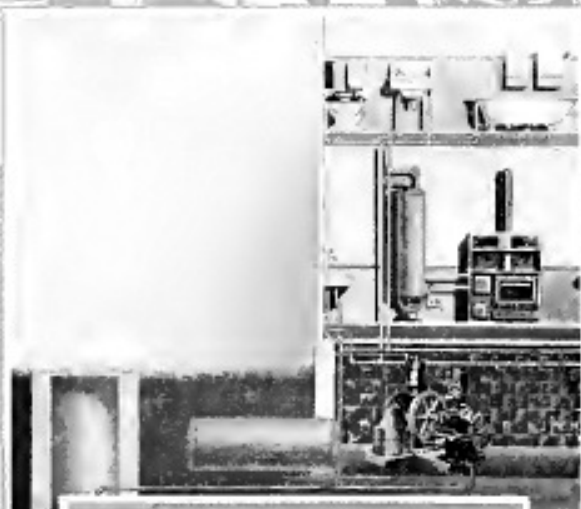

Plenty of water for everyone



Washing made easy

A Titan does your heavy work better,quicker,cheaper



Many farmers irrigate with a Titan



The big corn farmer needs a Titan



A Titan on one of the many barn jobs



Two economies—a Titan and a silo



A Titan makes milking easy



A common scene in the west—Titan and thresher

Titan Jr. 1-H. P. Gasoline Engine

The Little Engine
with the Big Pull



Titan Jr. 1-H. P. Gasoline Engine

Titan Jr. is the most compact and powerful engine of its weight on the market. It develops one full horse power and will do any of the small jobs that are such hard work on a hot day and take up so much of your time. Pumping the water, turning the grindstone, emery wheel, drill press, running small corn shellers, bone cutters, fanning mills, is just play for Titan Jr. For small, inexpensive, domestic water plants or spraying outfits, Titan Jr. cannot be equalled. It furnishes plenty of power and is so small and light that it takes up little space and is easily hauled around. This is a big point on the small spray rig.

It is just the thing for the woman to run. It's so simple and easy to operate. She can start it herself and run it without aid. It will relieve her of the drudgery of washing by running the washing machine and wringer. In the dairy it will run the cream separator, churn, and pump, in fact, it will pay for itself for this work alone.

Then the boys will appreciate Titan Jr. It takes the labor out of the chores and gives them an interest in the farm work, besides teaching them the use of machinery.

You will be surprised at the number of

different jobs this little engine can handle and how many backaches and how much annoyance it can save the whole family.

In construction Titan Jr. is a masterpiece. It combines all the features that go to make a reliable and substantial engine that will give real service, yet owing to the design, the weight has been kept down to the minimum without sacrificing power or durability. Like all the larger Titans, it is four cycle type. The cylinder is hopper-cooled with a drain cock underneath for draining in cold weather. Make-and-break ignition is used and batteries are regularly furnished for the current. The governor is of the hit-and-miss type and much simpler in construction than the usual design. The mixer will handle gasoline, benzine, naphtha, motor spirits or the better grades of kerosene without change. You don't have to buy high test gasoline either, as Titan Jr. burns the cheaper grades and motor spirits or good quality kerosene perfectly. You must see this little engine to really appreciate it. Titan Jr. is not a toy, but a full fledged 1-H. P. engine that will do a day's work. The first cost is so small and it is so economical to operate that every farmer needs one and can afford one.

Equipment—Titan Jr. 1-H. P. hopper-cooled engines are completely equipped—ready to run—with the following accessories: One 4-inch pulley with 5-inch face, one galvanized fuel tank, steel battery box, batteries, spark coil, switch, oil can, lubricating oil, and necessary tools. The engine and fuel tank are mounted on substantial wood skids.

Special Accessories—Special pulleys either 3 or 5 inches in diameter with 5-inch face can be furnished extra at additional cost, also a reducing gear for operating cream separators, churns, etc.

| H. P. | Speed R. P. M. | Regular Pulley | | Flywheel | | Capacity of Hopper Gallons | Capacity of Fuel Tank Gallons | Base Measures Inches | Height of Outfit Inches | Approximate Shipping Weight Pounds |
|-------|-------------------|--------------------|----------------|--------------------|----------------|----------------------------------|-------------------------------------|-------------------------|-------------------------------|--|
| | | Diameter Inches | Face Inches | Diameter Inches | Face Inches | | | | | |
| 1 | 650 | 4 | 5 | 14½ | 1¾ | 1 | ¾ | 23½x19 | 18½ | 149 |

"Tom Thumb" Air-Cooled Gasoline Engines

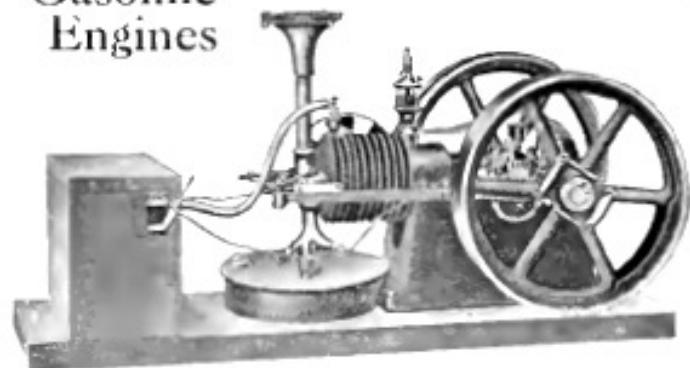

"Tom Thumb" 1-H. P. Air-Cooled Gasoline Engine

"Tom Thumb" is adapted to the light jobs around the farm and house. It is air-cooled—there is no water to freeze, and it is always ready to start at a minute's notice. The construction is extremely simple, and it is comparatively light in weight and easily moved. It is a four cycle type of engine with hit-and-miss governor, jump spark ignition, with a spark control lever.

No gasoline pump is used, but, instead, a simple mixer placed over the gasoline tank. A partial vacuum is produced in the pipe by the suction stroke of the piston and a flow of gasoline is induced into the mixer. The fuel is regulated by the needle valve. Both valves may be removed by unscrewing one bolt in the cylinder head. A belt-driven fan aids in cooling the cylinder. These engines are equipped to operate on gasoline, motor spirits, benzine, or naphtha.

Equipment—"Tom Thumb" air-cooled engines are equipped complete ready to run with the following accessories: Galvanized steel fuel tank, plain pulley, battery box, batteries, jump-spark coil, switch, spark plug, oil can and necessary tools, all mounted on a solid wood base.

Special Accessories—A 6-inch pulley with a 5-inch face that can be used for operating the standard and walking beam pumping jacks, a reducing gear can be supplied on special order. A 4-inch pulley with either a 2½-inch or 5-inch face and a 3 x 2½-inch pulley may also be had on special order. A magneto and bracket and a special hand truck can be furnished for this engine on special order. See pages 28 to 31.

Titan 1¹/₂ H.P. Hopper-Cooled Gasoline Engines



Titan 1-H. P. Hopper-Cooled Gasoline Engine

Titan 1-H. P. hopper-cooled gasoline engines are particularly desirable for the light work around the farm and in the country homes, such as pumping water, running cream separator, churn, washing machine, bone cutter, fanning mill, grindstone, etc., or for operating domestic water works, and electric light plants not requiring over one horse power. These powerful little engines are perfect in every respect, embodying many of the features used on our larger engines, such as make-and-break ignition with magneto, removable cylinder head, etc.

The construction is similar to the "Tom Thumb" engine except the cylinder is hopper-cooled and the ignition is make-and-break, the current for which is furnished by a magneto. They will operate on gasoline, motor spirits, benzine, or naphtha.

Equipment—Titan 1-H. P. hopper-cooled engines are completely equipped—ready to run—with the following accessories: One plain pulley, one galvanized fuel tank, tool box, magneto, oil can, lubricating oil and necessary tools, all mounted on a substantial solid wood base.

Special Accessories—A reducing gear, a special 6-inch pulley with a 5-inch face for operating the standard and walking beam pump jacks, also a special 4-inch pulley with either a 2½-inch or 5-inch face, can be supplied on special order. Special hand trucks can be supplied for these engines. See pages 28 to 31.

| Type | H. P. | Speed R. P. M. | Regular Pulley | | Flywheel | | Capacity of Hopper Gallons | Capacity of Fuel Tank Gallons | Base Measures Inches | Height of Outfit Inches | Approximate Shipping Weight Pound |
|---------------|-------|-------------------|--------------------|----------------|--------------------|----------------|-------------------------------------|--|----------------------------|----------------------------------|--|
| | | | Diameter Inches | Face Inches | Diameter Inches | Face Inches | | | | | |
| Air cooled | 1 | 600 | 6 | 5 | 15½ | 2¼ | | ¾ | 20 ½ x 42 | 21¾ | 280 |
| Hopper cooled | 1 | 600 | 6 | 5 | 15½ | 2¼ | 1½ | ¾ | 20 ¾ x 42 | 25 | 300 |

Titan 2½-H. P. Hopper Cooled Skidded Gasoline Engine

Titan 2½-H. P. Hopper Cooled Stationary Gasoline Engine

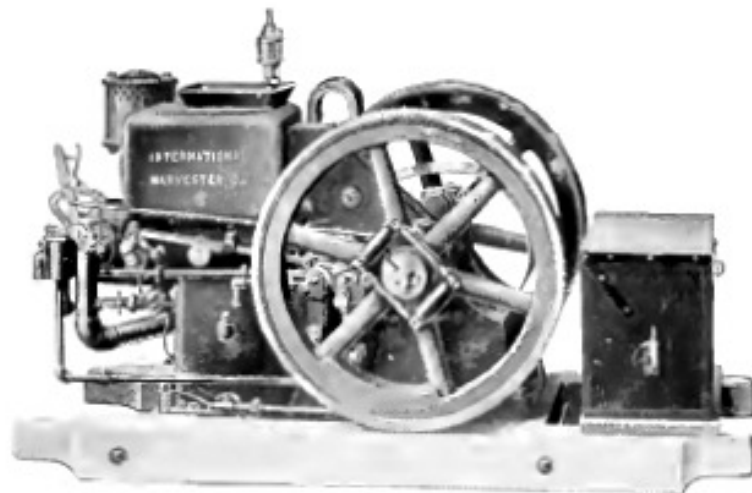

Titan 2½-H. P. Skidded Gasoline Engine

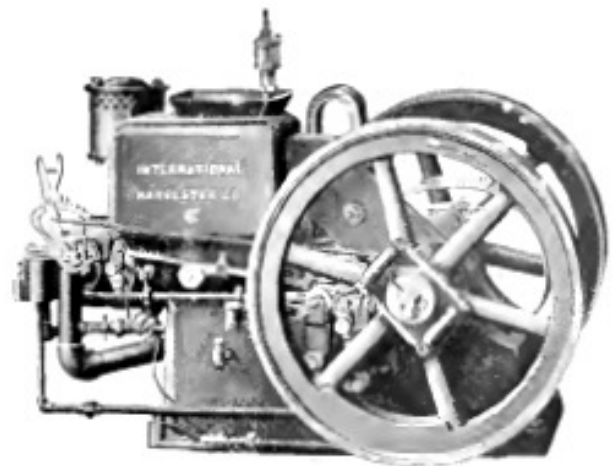

Titan 2½ H. P. Stationary Gasoline Engine

The Titan 2½-H. P. hopper-cooled skidded engine is the best all around small engine for the farm. It will run all the small machines economically that can be operated by a 1-H. P. engine, and in addition will operate small grinders, electric light plants, large spraying outfits, etc. The general construction is similar to the larger Titan engines, except it is designed to run on gasoline, motor spirits, benzine, or naphtha, and therefore has a gasoline mixer with a hit-and-miss governor. The base is a single casting. A special feature is the crank shaft which is extended ¼ inches on the pulley side so that it can be geared to a spray or domestic water pump. This engine is very compact and has proved to be one of the most convenient farm engines ever designed.

Equipment—Titan 2½-H. P. horizontal hopper-cooled skidded engines are completely equipped—ready to run—with the following accessories: One regular size plain pulley, magneto, one muller, one galvanized fuel tank, tool box, oil, oil can and necessary tools, all mounted on substantial wood skids.

Special Accessories—Different size pulleys, friction clutch pulleys, special mixers, etc., and hand truck can be furnished on special order. See pages 28 to 32.

The Titan 2½-H. P. hopper-cooled stationary engine is just the right size for the small shop, dairy, domestic water plants, home electric light plants, and the like. The simple construction and compactness gives these engines a great advantage where a small power plant is needed and has made them one of the most popular engines for this work. Like the skidded type, they are designed to operate on gasoline, motor spirits, benzine, or naphtha. They have all the modern improvements including a gear driven magneto which makes batteries unnecessary, a large fuel tank with piping which can be buried in the ground outside the building and many other features of the large Titan engines. The construction is substantial throughout and this engine will give reliable power.

Equipment—Titan hopper-cooled stationary engines are equipped complete for running with the following accessories: One galvanized steel fuel tank with two lengths of pipe and fittings, one regular size plain pulley, exhaust pot with one length of pipe, magneto, tool box, can of oil and necessary tools.

Special Accessories—Special size plain pulleys, friction clutch pulleys, special alcohol and gas mixer, etc., furnished on special order. See pages 28 to 32.

| Type of Engine | H. P. | Speed R.P.M. | Max. R. P. M. with Speed Changing Device | Regular Pulley | | Flywheel | | Capacity of Hopper Gallons | Capacity of Fuel Tank Gallons | Floor Space Inches | | Height of Outfit Inches | Approximate Shipping Weight, Pounds |
|----------------|-------|--------------|--|-----------------|-------------|-----------------|-------------|----------------------------|-------------------------------|--------------------|--------|-------------------------|-------------------------------------|
| | | | | Diameter Inches | Face Inches | Diameter Inches | Face Inches | | | Width | Length | | |
| Skidded | 2½ | 500 | 550 | 5 | 5½ | 22 | 2¼ | 3½ | 3 | 28½ | 54 | 32½ | 695 |
| Stationary | 2½ | 500 | 550 | 5 | 5½ | 22 | 2¼ | 3½ | 9 | 28¾ | 41 | 28¾ | 757 |

Titan Vertical Skidded Gasoline Engines



Titan 2-H. P. Vertical Skidded Gasoline Engine

The Titan vertical skidded engine has always been one of the most popular engines for stock and dairy farmers for pumping, grinding feed, shelling corn, etc. It takes up but little room, is easily moved from job to job, and is so simple and reliable that the minimum of attention is required. For this reason contractors find them desirable for operating concrete mixers, pumps and other machinery requiring small power. It is fitted for operation on gasoline, motor spirits, benzine, or naphtha. This engine is high-grade in every respect and will give the maximum of service. A description of the construction will be found on pages 33 to 35.

Nonpareil Type Skidded Gasoline Engines

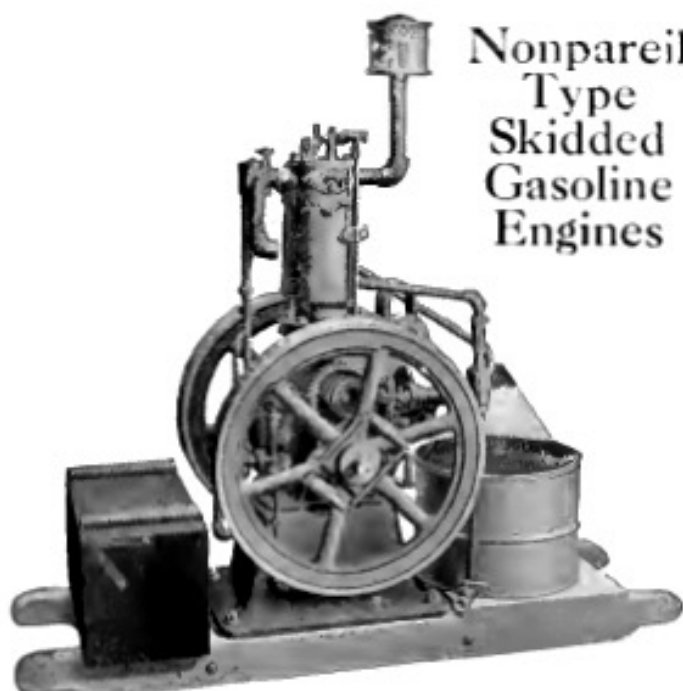

Nonpareil 2-H. P. Skidded Gasoline Engine

The Nonpareil type skidded vertical engine is similar to the regular Titan vertical engine except it is not built quite so heavy and is different in a few minor details. The equipment is the same and it will give as good service up to its capacity. In many instances it is preferred on account of its lighter weight and the many sizes in which it is built. It will operate on gasoline, motor spirits, benzine, or naphtha. All sizes are equipped with high-grade magneto, the same as the Titan. For all round farm work, this is a very desirable power plant and will give satisfaction in every case. Up to its horse power rating.

Equipment—Titan Vertical Skidded Engines and Nonpareil Skidded Engines—Galvanized steel gasoline tank in base of engine, galvanized steel cooling tank, one regular size plain pulley, magneto, muffler, tool box with tools, cylinder lubricator, and oil can, all mounted on substantial wooden base. Batteries, spark coil, wiring and switch furnished on 6-H. P. size; other sizes can be started on magneto.

Special Accessories—Different size plain pulleys, friction clutch pulley, hand trucks and special mixers furnished on special order. See pages 26 to 32.

| Type of Engine | H. P. | Normal Speed R. P. M. | Speed R. P. M. with Speed Changing Device | Pulley | | Flywheel | | Fuel Tank Capacity Gallons | Base Measures Inches | | Height Inches Over All | Approximate Shipping Weight Pounds Domestic |
|----------------|-------|-----------------------|---|-----------------|-------------|-----------------|-------------|----------------------------|----------------------|----------------|------------------------|---|
| | | | | Diameter Inches | Face Inches | Diameter Inches | Face Inches | | Length of Skids | Width of Skids | | |
| Titan | 2 | 100 | 130 | 8 | 5 | 21 | 21½ | 3 | 62 | 30 ¾ | 48 ¾ | 810 |
| Titan | 3 | 360 | 440 | 9 | 5½ | 26½ | 21½ | 3 | 63 | 32 ½ | 51 ¾ | 990 |
| Nonpareil | 2 | 160 | 420-500 | 5 | 5½ | 22 | 21¼ | 1¾ | 57¾ | 18¼ | 41 ¾ | 595 |
| Nonpareil | 3 | 450 | 375-470 | 8 | 5 | 21 | 21½ | 3 | 62 | 18¼ | 50 ¾ | 315 |
| Nonpareil | 4 | 450 | 100-175 | 9 | 5½ | 30 | 23½ | 3 | 63 | 20¾ | 55¼ | 1000 |
| Nonpareil | 6 | 350 | 325-390 | 14 | 12¼ | 33 | 21½ | 7 | 71½ | 29¼ | 63¾ | 1410 |

**Titan
Type "A"
Stationary
Vertical
Gasoline
Engines**

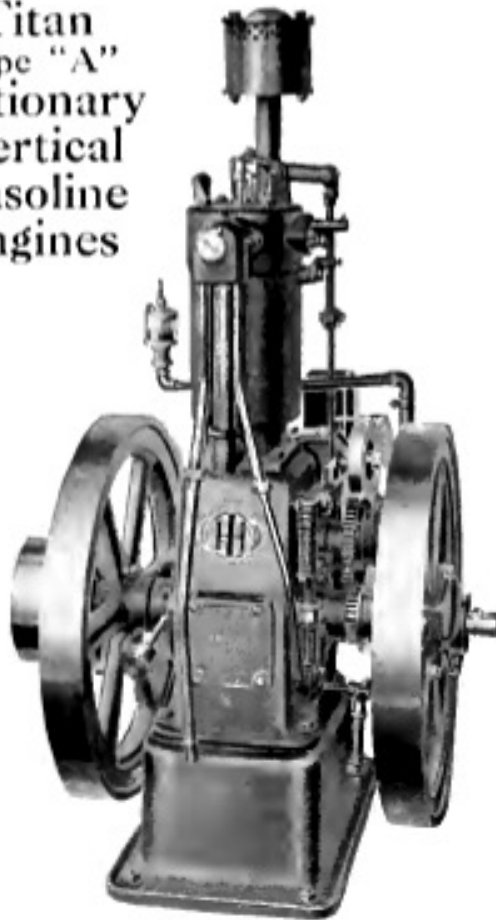

Titan Vertical Stationary Engine

Titan vertical stationary engines are the ideal vertical power plants. They furnish a large surplus of power over their rating and are one of the most reliable engines ever designed. They will operate on gasoline, motor spirits, benzine, or naphtha. A detailed description of the construction will be found on pages 33 to 35.

**Nonpareil
Type
Stationary
Gasoline
Engines**

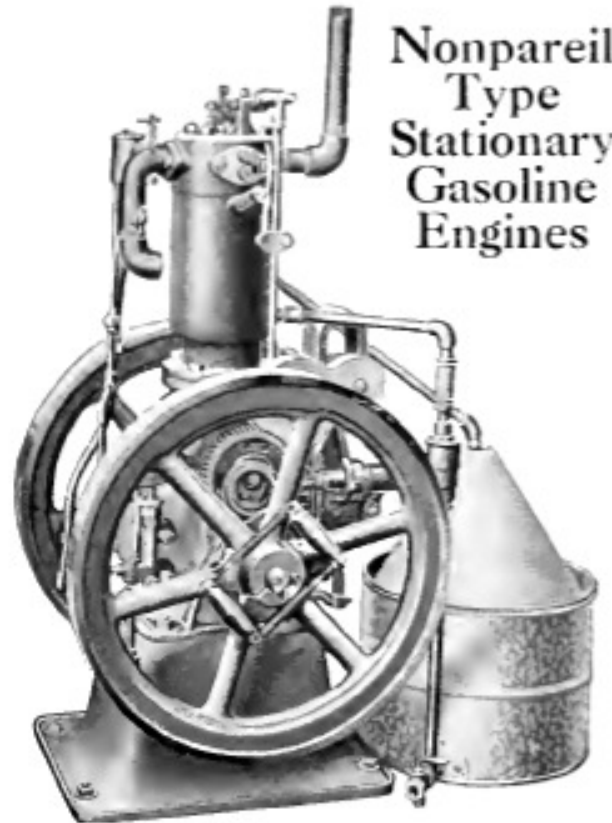

Nonpareil Type Stationary Engine

The Nonpareil type stationary engine is a very satisfactory source of power for the small shop, farm, or dairy. It is somewhat lighter in weight than the regular Titan engine, but the general construction is nearly identical and the equipment is the same. It operates on gasoline, motor spirits, benzine, or naphtha.

Equipment—Titan Type "A" and Nonpareil engines—Plain pulley, magneto, muffler, galvanized steel gasoline tank with pipe and fittings to install the tank outside the building, galvanized steel cooling tank with pipe and fittings, exhaust pipe, oil can, and tool box; template and anchor bolts on 6-H.P. size; necessary tools. Batteries, spark coil, wiring and switch furnished with 6-H.P. Nonpareil; other sizes can be started on magneto.

Special Accessories—Exhaust pot, different size plain pulleys, friction clutch pulleys and special mixers, furnished on special order. See pages 28 to 32.

| Type of Engine | H. P. | Speed R.P.M. | Max. R. P. M. with Speed Changing Device | Regular Pulley | | Flywheel | | Fuel Tank | | | Floor Space Inches | Height Inches | Approximate Shipping Weight Pounds Domestic |
|----------------|-------|--------------|--|-----------------|------------------|------------------|------------------|---------------|---------------|------------------|-------------------------------------|------------------|---|
| | | | | Diameter Inches | Face Inches | Diameter Inches | Face Inches | Capacity Gal. | Length Inches | Diameter Inches | | | |
| Titan | 2 | 400 | 480 | 8 | 5 | 21 | 21 $\frac{1}{2}$ | 9 | 20 | 12 | 30 $\frac{1}{6}$ x 21 | 15 | 880 |
| Titan | 3 | 360 | 440 | 9 | 5 $\frac{1}{2}$ | 26 $\frac{1}{2}$ | 21 $\frac{1}{2}$ | 9 | 20 | 12 | 31 $\frac{3}{4}$ x 26 $\frac{1}{2}$ | 18 | 1015 |
| Nonpareil | 2 | 460 | 420-500 | 5 | 5 $\frac{1}{2}$ | 22 | 21 $\frac{1}{4}$ | 9 | 20 | 12 | 28 $\frac{1}{4}$ x 42 | 38 | 615 |
| Nonpareil | 3 | 450 | 375-470 | 8 | 5 | 24 | 21 $\frac{1}{2}$ | 9 | 20 | 12 | 30 $\frac{5}{8}$ x 43 | 17 | 845 |
| Nonpareil | 4 | 450 | 400-475 | 9 | 5 $\frac{1}{2}$ | 30 | 21 $\frac{3}{8}$ | 9 | 20 | 12 | 32 $\frac{1}{8}$ x 45 | 51 $\frac{1}{2}$ | 1035 |
| Nonpareil | 6 | 350 | 325-390 | 14 | 12 $\frac{1}{4}$ | 33 | 21 $\frac{1}{2}$ | 54 | 48 | 18 $\frac{3}{4}$ | 40 $\frac{5}{16}$ x 54 | 59 | 1630 |

Titan Tank-Cooled Skidded Oil Engine

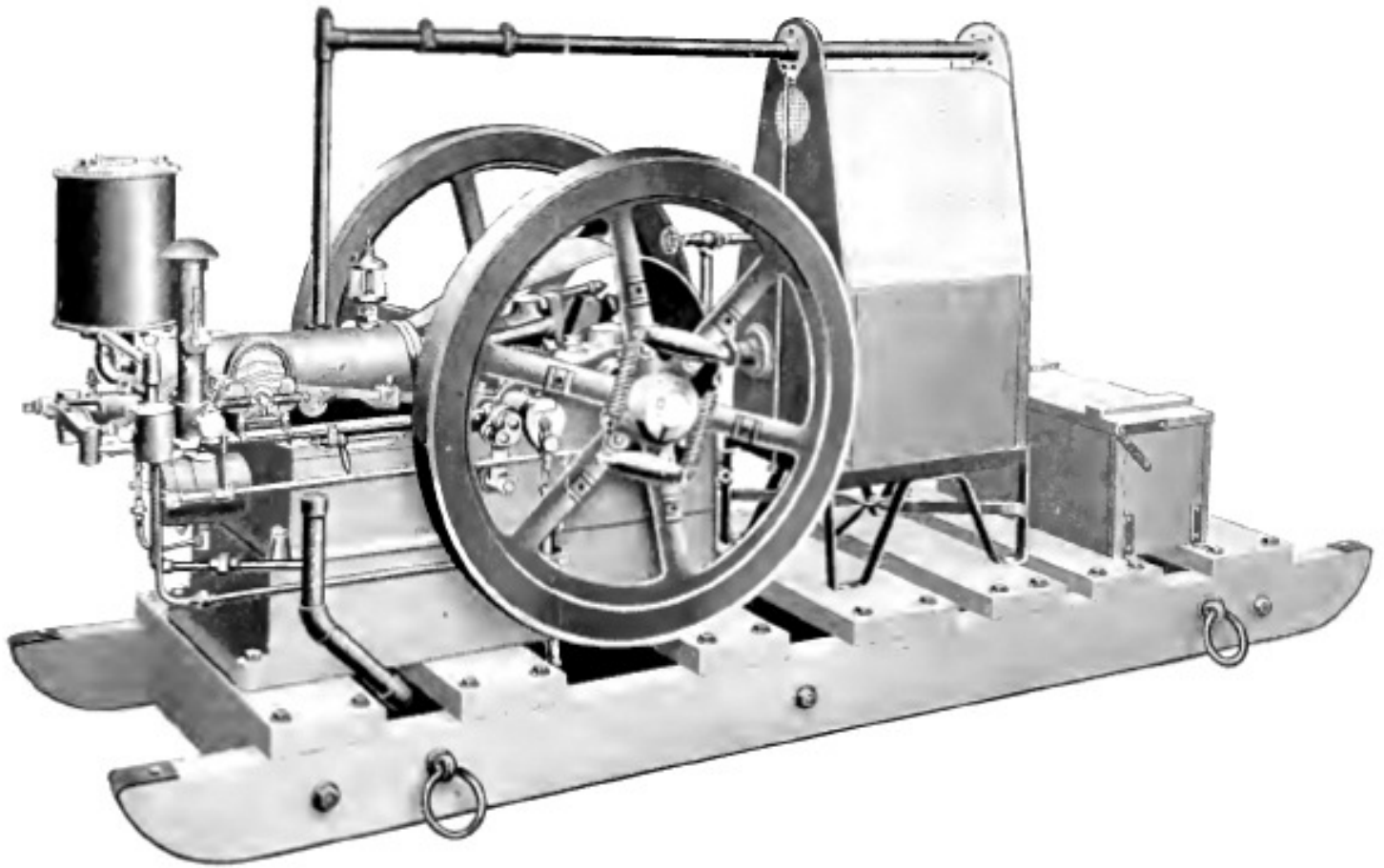

Titan Tank-Cooled Skidded Oil Engine—6 to 12-H. P. Type

This is the real farmer's engine for general farm work. It operates on low grade cheap fuels which will cut down your fuel bills surprisingly. It is provided with iron shod substantial skids equipped with hauling rings making it an easy matter to move it from one job to another. It is made in several sizes to

suit the work on nearly every farm. This outfit is complete and self contained, the engine and all equipment being mounted on the skids. It will operate on kerosene, distillate down to 39° Baume, solar oil, gas oil, motor spirits, naphtha, or gasoline. A description of the construction will be found on pages 36 to 40.

Equipment—Titan skidded oil engines are equipped complete for running with the following accessories: One galvanized steel fuel tank in the base of the engine, galvanized steel cooling tank, one regular size plain pulley, magneto, muller, tool box with tools, cylinder lubricator, oil can, and large can of the best gas engine lubricating oil, all mounted on substantial wooden skids, making a compact self-contained outfit. Switch, spark coil and batteries furnished on 1-H. P. only; others can be started on magneto.

Special Accessories—Special size plain pulleys, friction clutch pulleys, and other special accessories can be furnished on special order. See pages 28 to 32.

| H. P. | Speed R. P. M. | Regular Pulley | | Flywheel | | Fuel Tank Gallons | Floor Space | | Height Inches | Approximate Shipping Weight, Pounds |
|-------|-------------------|--------------------|------------------|--------------------|------------------|----------------------|----------------------------|----------------------------|------------------|--|
| | | Diameter Inches | Face Inches | Diameter Inches | Face Inches | | Length of Skids, Inches | Width of Engine, Inches | | |
| 1 | 450 | 12 | 3 $\frac{3}{8}$ | 33 | 21 $\frac{1}{2}$ | 5 | 106 | 31 $\frac{3}{4}$ | 50 | 1550 |
| 6 | 390 | 16 | 12 $\frac{1}{4}$ | 40 $\frac{1}{2}$ | 21 $\frac{1}{2}$ | 11 | 120 | 42 $\frac{1}{2}$ | 53 | 2120 |
| 8 | 375 | 18 | 10 $\frac{1}{4}$ | 45 | 3 | 18 | 132 | 43 | 60 $\frac{1}{2}$ | 2805 |
| 10 | 350 | 20 | 10 $\frac{1}{4}$ | 49 $\frac{1}{2}$ | 3 | 20 | 131 $\frac{1}{2}$ | 43 $\frac{3}{4}$ | 61 $\frac{3}{8}$ | 3010 |
| 12 | 300 | 24 | 11 $\frac{1}{4}$ | 51 | 3 | 30 | 138 | 49 $\frac{3}{8}$ | 62 $\frac{3}{4}$ | 4000 |

Titan Hopper-Cooled Skidded Oil Engines

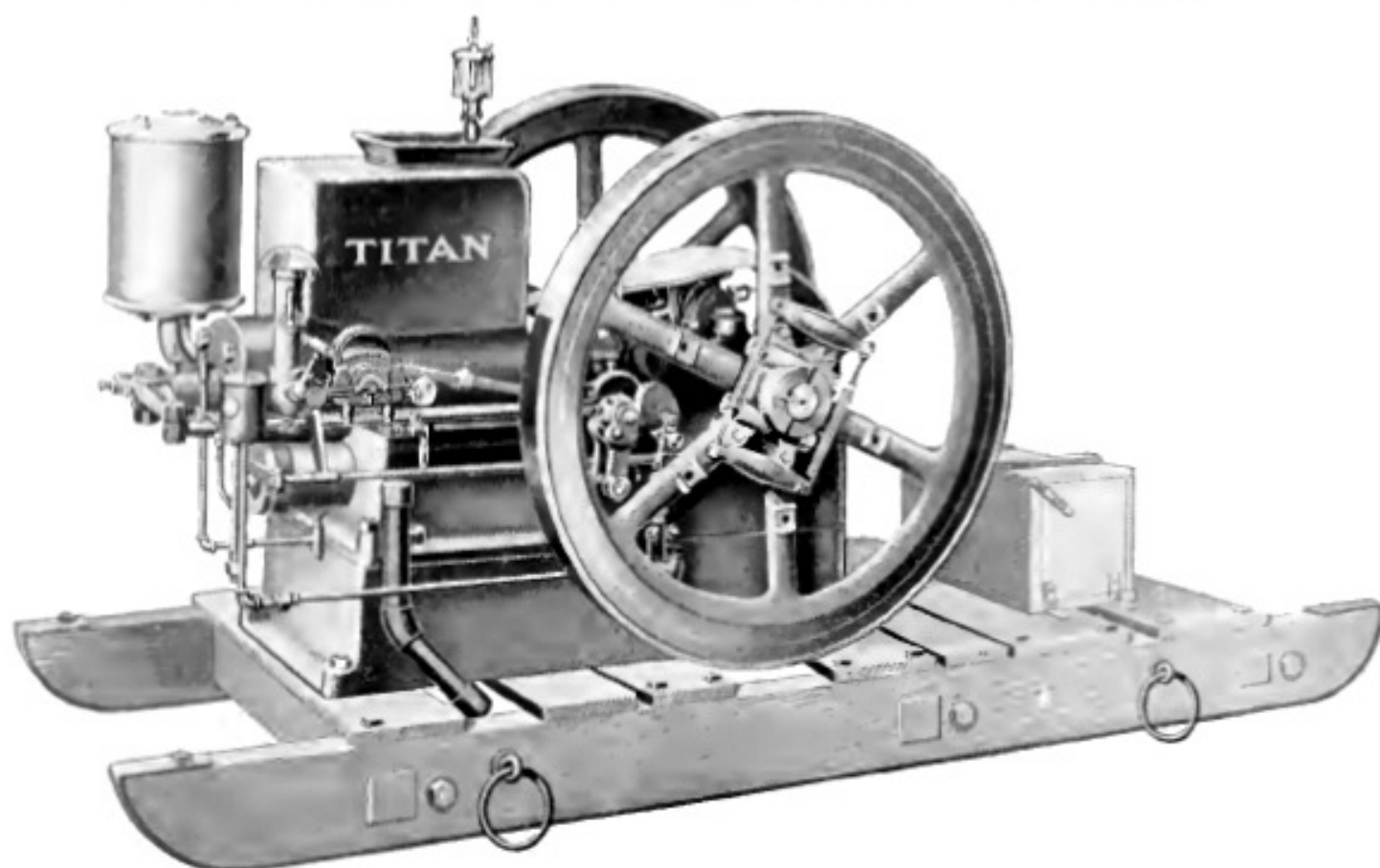

Titan Horizontal Hopper-Cooled Skidded Oil Engine—6 to 12-H. P. Type

This engine is identical with the Titan tank-cooled skidded engine except it is hopper-cooled, which makes it somewhat lighter in weight and a little less bother to get ready if the water has been drained out. It is an easy outfit to haul around and is more in demand in the northern districts where an

engine cools easily and the engine has to be drained frequently on account of frost. It operates on kerosene, distillate down to 39° Baume, gas oil, solar oil, motor spirits, benzine, naphtha, or gasoline without any change. For detailed description, see pages 36 to 40.

Equipment—Titan horizontal hopper-cooled skidded oil engines are completely equipped ready to run with the following accessories: One regular size plain pulley, magneto, one muffler, one galvanized fuel tank, tool box, oil can, oil and necessary tools, all mounted on substantial wood skids. Batteries, spark coil, switch and wiring furnished on 4-H. P. engine; other sizes can be started on magneto.

Special Accessories—Different size plain pulleys, friction clutch pulleys, and many other accessories can be furnished on special order. See pages 28 to 32.

| H. P. | Speed H. P. M. | Regular Pulley | | Flywheel | | Capacity of Hopper Gallons | Capacity of Fuel Tank Gallons | Base Measures Inches | | Height of Outfit Inches | Approximate Shipping Weight, Pounds |
|-------|-------------------|--------------------|------------------|--------------------|-----------------|-------------------------------------|--|-------------------------|--------------------|----------------------------------|--|
| | | Diameter Inches | Face Inches | Diameter Inches | Face Inches | | | Width of Engine | Length of Skids | | |
| 1 | 450 | 12 | 8 $\frac{3}{4}$ | 33 | 2 $\frac{1}{2}$ | 6 | 5 | 31 $\frac{3}{4}$ | 81 | 41 $\frac{5}{8}$ | 1470 |
| 6 | 390 | 16 | 12 $\frac{3}{4}$ | 40 $\frac{1}{2}$ | 2 $\frac{1}{2}$ | 12 | 11 | 42 $\frac{1}{2}$ | 93 | 52 $\frac{1}{8}$ | 1975 |
| 8 | 375 | 18 | 10 $\frac{1}{4}$ | 45 | 3 | 16 | 18 | 43 | 97 $\frac{3}{8}$ | 56 $\frac{3}{8}$ | 2600 |
| 10 | 350 | 20 | 10 $\frac{1}{2}$ | 49 $\frac{1}{2}$ | 3 | 20 | 20 | 43 $\frac{3}{4}$ | 99 $\frac{1}{8}$ | 60 $\frac{3}{8}$ | 3020 |
| 12 | 300 | 24 | 14 $\frac{1}{4}$ | 54 | 3 | 22 | 30 | 49 $\frac{3}{8}$ | 101 | 64 $\frac{3}{4}$ | 3740 |

Titan Tank-Cooled Stationary Oil Engines

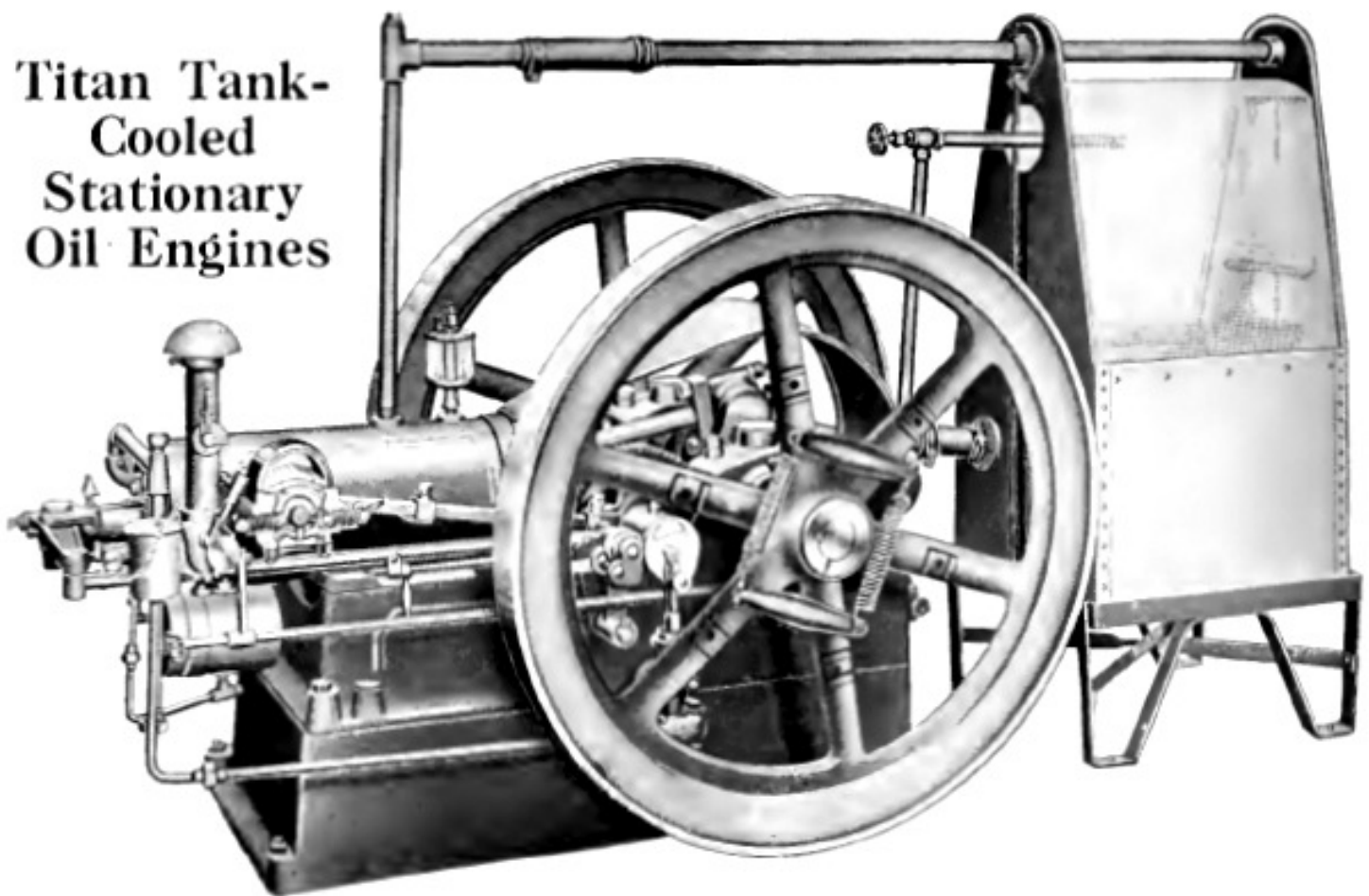

Titan Stationary 6 to 25-H. P. Oil Engine with Cooling Tank

The Titan tank-cooled stationary engines are adapted to heavy power work and will deliver reliable power under the most severe conditions of service. The throttling governor gives them very close regulation and adapts them for electric lighting or other work requiring close regulation. They are also very

economical as they will operate on kerosene, distillate down to 39° Baume, gas oil, solar oil, or motor spirits. Without change they can be operated on benzine, naphtha, or gasoline. Built in magneto is used on all sizes. A description of the construction will be found on pages 36 to 40.

Equipment—Titan stationary oil engines are fully equipped for running and include the following accessories: One galvanized steel fuel supply tank with two lengths of pipe and fittings to install the tank outside of the building and connect it with the engine, one galvanized steel cooling tank with pipe and fittings and rubber hose to connect it with the engine, one exhaust pot and one length of exhaust pipe, magneto, tool box, one plain pulley, oil can, necessary tools, cylinder lubricator, template and anchor bolts. Switch, spark coil, wiring and batteries furnished on 4-H. P. engine; other sizes can be started on magneto.

Special Accessories—Special size plain pulleys, friction clutch pulleys, and other accessories can be furnished on special order, see pages 28 to 32.

| H. P. | Speed R. P. M. | Regular Pulley | | Flywheel | | Fuel Tank | | | Floor Space Inches | Height Inches | Approximate Shipping Weight Pounds |
|-------|-------------------|--------------------|--------------------------------|--------------------------------|-------------------------------|------------------|--------------------------------|---------------------|--|--------------------------------|---|
| | | Diameter Inches | Face Inches | Diameter Inches | Face Inches | Length Inches | Diameter Inches | Capacity Gallons | | | |
| 4 | 150 | 12 | 8 ³ / ₈ | 33 | 2 ¹ / ₂ | 30 | 12 | 11 | 35 ¹ / ₂ x 51 ³ / ₈ | 42 ¹ / ₈ | 1195 |
| 6 | 390 | 16 | 12 ¹ / ₄ | 40 ¹ / ₂ | 2 ¹ / ₂ | 48 | 18 ¹ / ₄ | 51 | 40 ³ / ₈ x 65 ¹ / ₁₆ | 44 ¹ / ₈ | 2085 |
| 8 | 375 | 18 | 10 ¹ / ₄ | 15 | 3 | 48 | 18 ¹ / ₄ | 51 | 42 ³ / ₈ x 71 ³ / ₈ | 51 ¹ / ₈ | 2770 |
| 10 | 350 | 20 | 10 ¹ / ₄ | 19 ¹ / ₂ | 3 | 48 | 18 ¹ / ₄ | 51 | 43 ³ / ₈ x 77 ¹ / ₄ | 52 ³ / ₈ | 3090 |
| 12 | 300 | 24 | 11 ¹ / ₄ | 51 | 3 | 48 | 18 ¹ / ₄ | 51 | 49 ³ / ₈ x 85 ¹ / ₂ | 51 ¹ / ₄ | 3830 |
| 15 | 275 | 26 | 12 ¹ / ₂ | 63 | 3 | 48 | 18 ¹ / ₄ | 51 | 49 ¹ / ₄ x 98 ¹ / ₂ | 63 | 5150 |
| 20 | 275 | 28 | 16 ¹ / ₄ | 60 | 3 ³ / ₄ | 48 | 18 ¹ / ₄ | 51 | 57 ¹ / ₈ x 102 ³ / ₈ | 61 ¹ / ₈ | 6285 |
| 25 | 260 | 28 | 16 ¹ / ₂ | 60 | 4 ¹ / ₂ | 48 | 18 ¹ / ₄ | 51 | 61 ¹ / ₂ x 139 ¹ / ₂ | 60 ¹ / ₂ | 7765 |

Titan Hopper-Cooled Stationary Oil Engines

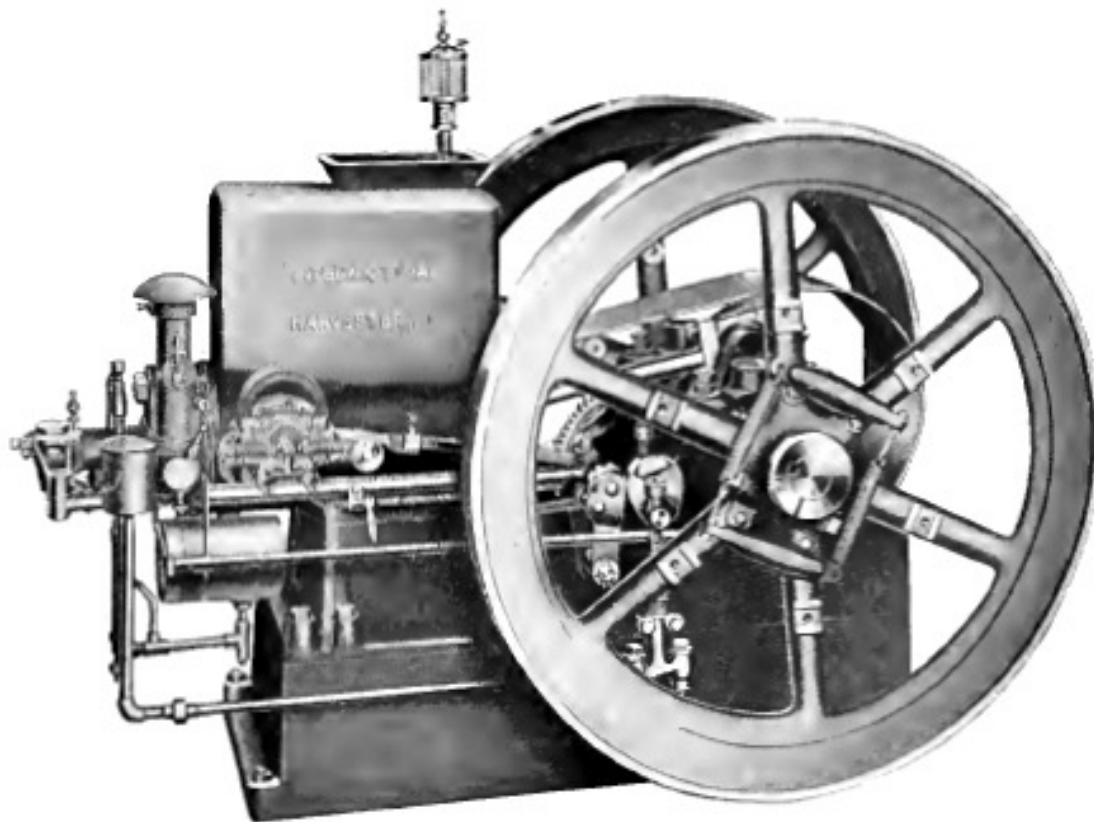

Titan 6 to 12-H. P. Stationary Hopper-Cooled Oil Engine

Titan hopper-cooled stationary oil engines are more convenient for farm work than the tank-cooled type of engine as they require but little water for cooling and can be drained more quickly in cold weather. They are also desirable where space is a factor as there is no cooling tank. In cold weather hot water can

be poured into the hopper which facilitates starting. They will operate on kerosene, distillate down to 39° Baume, gas oil, solar oil, motor spirits, benzine, naphtha, or gasoline, without change of adjustment. A description of the construction will be found on pages 36 to 40.

Equipment—Titan hopper-cooled stationary engines are equipped complete for running with the following accessories: One galvanized steel fuel tank with two lengths of pipe and fittings, one regular size plain pulley, magneto, exhaust pot with one length of pipe, tool box, template, anchor bolts, can of oil, and necessary tools. Batteries, spark coil, switch and wiring are furnished on the 4-H. P. engine; other sizes can be started on magneto.

Special Accessories—Special size plain pulleys, friction clutch pulleys, etc., can be furnished on special order. See pages 28 to 32.

| H. P. | Speed R. P. M. | Regular Pulley | | Flywheel | | Capacity of Hopper Gallons | Capacity of Fuel Tank Gallons | Floor Space Inches | Height Over All, Inches | Approximate Shipping Weight, Pounds |
|-------|-------------------|--------------------|------------------|--------------------|-----------------|-------------------------------------|--|-------------------------------------|----------------------------------|--|
| | | Diameter Inches | Face Inches | Diameter Inches | Face Inches | | | | | |
| 4 | 450 | 12 | 8 $\frac{3}{8}$ | 33 | 2 $\frac{1}{2}$ | 6 | 14 | 31 $\frac{3}{4}$ x 78 $\frac{3}{4}$ | 37 $\frac{1}{2}$ | 1130 |
| 6 | 390 | 16 | 12 $\frac{3}{4}$ | 40 $\frac{1}{2}$ | 2 $\frac{1}{2}$ | 12 | 54 | 12 $\frac{1}{2}$ x 51 $\frac{1}{2}$ | 43 $\frac{3}{4}$ | 2035 |
| 8 | 375 | 18 | 10 $\frac{3}{4}$ | 45 | 3 | 16 | 54 | 13 x 66 $\frac{3}{4}$ | 48 | 2670 |
| 10 | 350 | 20 | 10 $\frac{3}{4}$ | 49 $\frac{1}{2}$ | 3 | 20 | 54 | 13 $\frac{3}{4}$ x 73 | 52 | 3015 |
| 12 | 300 | 24 | 11 $\frac{3}{4}$ | 54 | 3 | 22 | 54 | 19 $\frac{5}{8}$ x 87 $\frac{1}{2}$ | 56 | 3300 |

Titan Tank-Cooled Portable Oil Engines

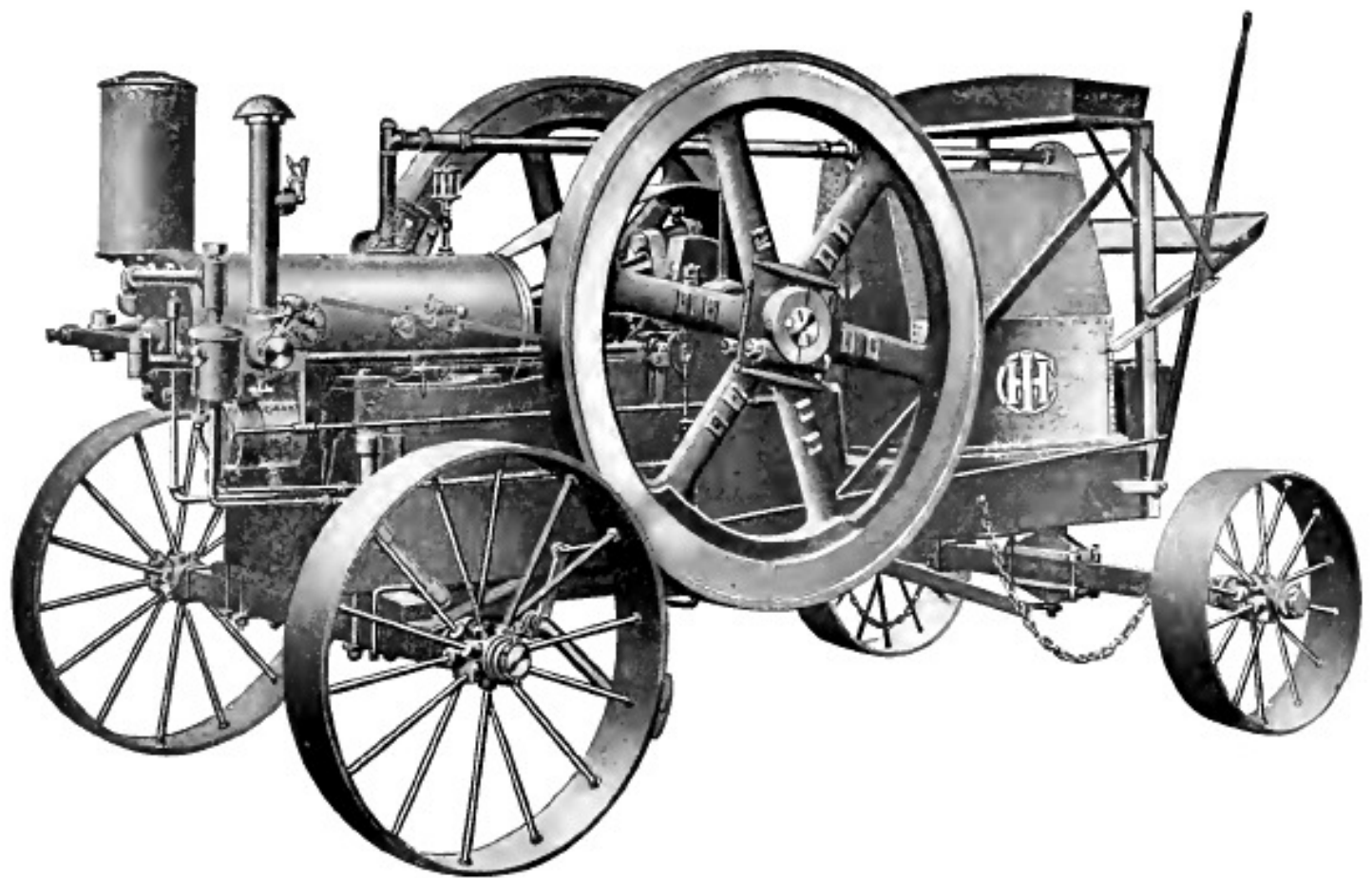

Titan Tank-Cooled Portable Oil Engine—20 and 25-H. P. type.

The Titan tank-cooled portable oil engine is suited to the most severe service such as threshing, irrigating, etc. The trucks are steel, amply strong to negotiate the roughest

roads. The engine operates on kerosene, distillate down to 39° Baume, gas oil, solar oil, motor spirits, benzine, naphtha, or gasoline. Description of parts on pages 36 to 40.

Equipment—Titan tank-cooled portable engines are completely equipped, ready to run, with the following accessories: One galvanized cooling tank, one galvanized fuel tank, exhaust muffler, friction clutch pulley, auto sparker, tool box, necessary tools, oil can, oil, wind shield, doubletrees, pole, neckyoke and wheel braces. A brake is regularly furnished with all 20 and 25-H. P. portable engines and can be furnished as an extra on other sizes. Wheels with 8-inch face can be furnished on special order for the 20-H. P. portable engine truck. These wheels cannot, however, be furnished for engines in the field. Batteries, spark coil, switch and wiring are furnished on all sizes.

Special Accessories—Special size pulleys, friction clutch pulleys, shafts in place of pole on 4 and 6-H. P. sizes, etc., can be furnished on special order. See pages 28 to 32.

| H. P. | Speed R. P. M. | Regular Friction Clutch Pulley | | Flywheel | | Capacity Fuel Tank Gallons | Tread Inches | Size Truck Wheels Inches | | Height Inches | Approximate Shipping Weight Pounds |
|-------|-------------------|-----------------------------------|------------------|--------------------|-----------------|-------------------------------------|------------------|-----------------------------|----------------------|------------------|---|
| | | Diameter Inches | Face Inches | Diameter Inches | Face Inches | | | Front | Rear | | |
| 4 | 450 | 20 | 6 $\frac{1}{2}$ | 33 | 2 $\frac{1}{2}$ | 7 | 44 | 21 x 3 $\frac{1}{2}$ | 26 x 3 $\frac{1}{2}$ | 61 $\frac{1}{2}$ | 2001 |
| 6 | 390 | 24 | 6 $\frac{3}{8}$ | 40 $\frac{1}{2}$ | 2 $\frac{1}{2}$ | 15 | 46 | 26 x 3 $\frac{1}{2}$ | 31 x 3 $\frac{1}{2}$ | 63 $\frac{1}{8}$ | 2605 |
| 8 | 375 | 26 | 6 $\frac{3}{8}$ | 45 | 3 | 20 | 49 $\frac{5}{8}$ | 30 x 4 | 33 x 4 | 73 $\frac{7}{8}$ | 3130 |
| 10 | 350 | 28 | 7 $\frac{1}{2}$ | 49 $\frac{1}{2}$ | 3 | 20 | 49 $\frac{5}{8}$ | 30 x 4 | 33 x 4 | 73 $\frac{7}{8}$ | 3790 |
| 12 | 300 | 30 | 9 $\frac{1}{2}$ | 51 | 3 | 30 | 57 $\frac{5}{8}$ | 30 x 6 | 33 x 6 | 79 | 4575 |
| 15 | 275 | 36 | 9 $\frac{1}{2}$ | 63 | 3 | 40 | 57 $\frac{5}{8}$ | 30 x 6 | 33 x 6 | 79 | 5750 |
| 20 | 275 | 40 | 10 $\frac{1}{2}$ | 60 | 3 $\frac{3}{4}$ | 42 | 68 | 30 x 6 | 33 x 6 | 79 $\frac{5}{8}$ | 6772 |
| 25 | 260 | 40 | 10 $\frac{1}{2}$ | 60 | 4 $\frac{1}{2}$ | 42 | 68 $\frac{1}{4}$ | 30 x 8 | 33 x 8 | 80 $\frac{1}{4}$ | 8862 |

Titan Hopper-Cooled Portable Oil Engines

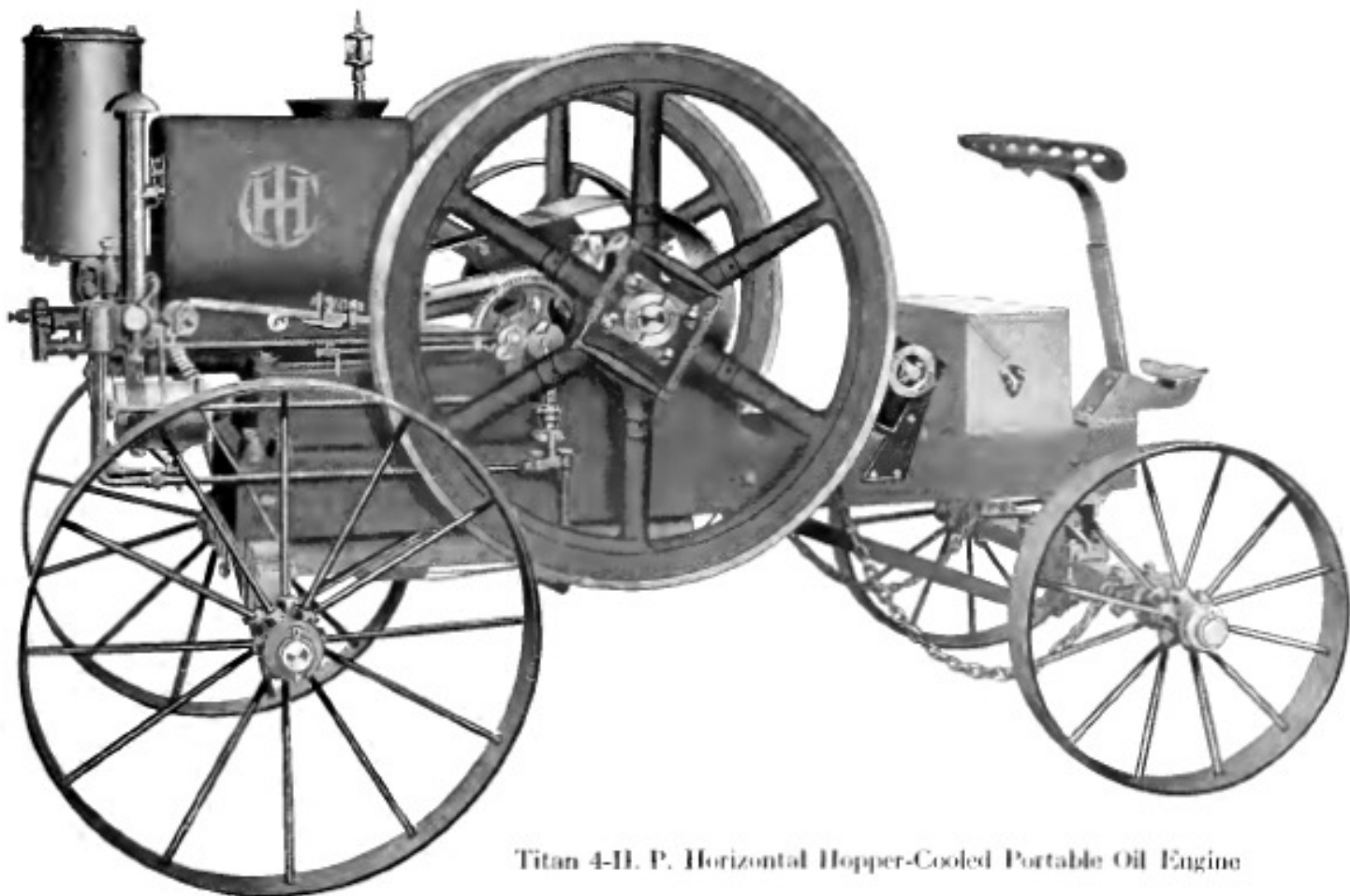

Titan 4-H. P. Horizontal Hopper-Cooled Portable Oil Engine

This engine is particularly adapted to general farm work. It is hopper-cooled and therefore requires little cooling water, and is quickly drained in cold weather. The truck is steel built to stand rough roads and hard

use. The engine will operate on kerosene, distillate down to 39° Baume, gas oil, solar oil, motor spirits, benzine, naphtha, or gasoline. A detailed description of the engine parts will be found on pages 36 to 40.

Equipment — Titan hopper-cooled portable oil engines are completely equipped for running, with the following accessories: One galvanized fuel tank, exhaust muffler, friction clutch pulley, auto sparker, tool box, necessary tools, oil can, oil, doubletrees, pole, neckyoke, and wheel braces. Batteries, spark coil, switch and wiring are furnished on all sizes.

Special Accessories — Special size plain pulleys, friction clutch pulleys, shafts in place of pole on 4 and 6-H. P. sizes, brake, etc., can be furnished on special order. See pages 28 to 32.

| H. P. | Speed R. P. M. | Regular Friction Clutch Pulley | | Flywheel | | Capacity Fuel Tank Gallons | Capacity Hopper Gallons | Tread Inches | Size of Truck Wheels Inches | | Height Inches | Approximate Shipping Weight, Pounds |
|-------|-------------------|-----------------------------------|-----------------|--------------------|-----------------|-------------------------------------|-------------------------------|------------------|--------------------------------|----------------------|------------------|--|
| | | Diameter Inches | Face Inches | Diameter Inches | Face Inches | | | | Front | Rear | | |
| 4 | 150 | 20 | 6 $\frac{1}{2}$ | 33 | 2 $\frac{1}{2}$ | 7 | 6 | 44 | 24 x 3 $\frac{1}{2}$ | 28 x 3 $\frac{1}{2}$ | 51 $\frac{3}{8}$ | 2005 |
| 6 | 390 | 21 | 6 $\frac{1}{2}$ | 40 $\frac{1}{2}$ | 2 $\frac{1}{2}$ | 15 | 12 | 46 | 26 x 3 $\frac{1}{2}$ | 31 x 3 $\frac{1}{2}$ | 59 $\frac{1}{8}$ | 2595 |
| 8 | 375 | 26 | 6 $\frac{1}{2}$ | 45 | 3 | 20 | 16 | 49 $\frac{5}{8}$ | 30 x 4 | 38 x 4 | 66 $\frac{5}{8}$ | 3135 |
| 10 | 350 | 28 | 7 $\frac{1}{2}$ | 49 $\frac{1}{2}$ | 3 | 20 | 20 | 49 $\frac{5}{8}$ | 30 x 4 | 38 x 4 | 68 $\frac{7}{8}$ | 3740 |
| 12 | 300 | 30 | 9 $\frac{1}{2}$ | 54 | 3 | 30 | 22 | 57 $\frac{5}{8}$ | 30 x 6 | 38 x 6 | 70 $\frac{1}{2}$ | 4200 |

Titan Tank-Cooled Oil Mounting Engines

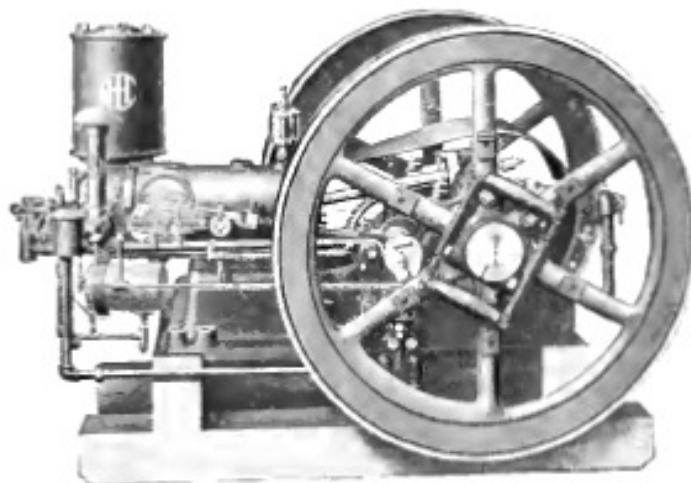

Titan 6 to 20-H. P. Type Tank-Cooled Oil Mounting Engine

These engines are identical with the Titan tank-cooled stationary engine except the sub-base has been omitted and a special square fuel tank is supplied for convenience in mounting. They are extensively used for mounting on small threshers, saw rigs, hay balers, etc. They will operate on kerosene, distillate down to 39° Baume, gas oil, solar oil, benzine, naphtha, motor spirits, or gasoline. Description of parts on pages 36 to 40.

Titan Hopper-Cooled Oil Mounting Engine

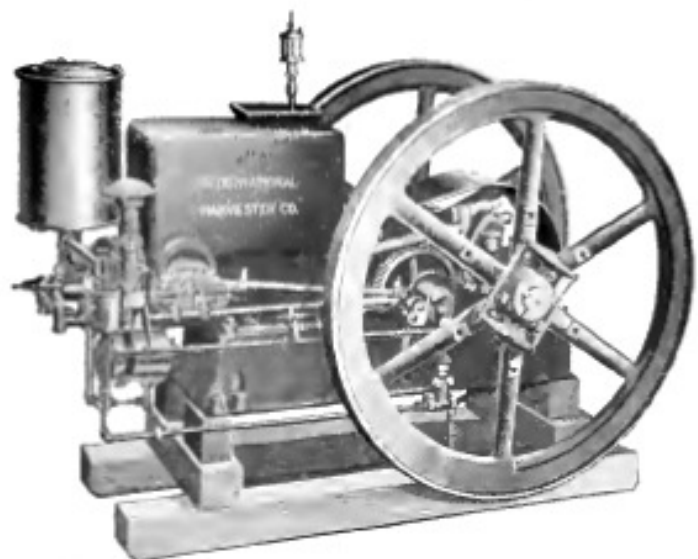

Titan 6 to 12-H. P. Type Oil Mounting Engine

The Titan hopper-cooled mounting engine is designed to meet the requirements for an engine that can be easily mounted on a farm truck, bob sled, or skid, or in connection with any special machines such as wood saws, concrete mixers, well drills, pumping plants, etc. They operate on kerosene, distillate down to 39° Baume, gas oil, solar oil, motor spirits, benzine, naphtha, or gasoline. A description of parts will be found on pages 36 to 40.

Equipment — Titan oil mounting engines are equipped complete for running with the following accessories: One regular size plain pulley, magneto, one square galvanized fuel tank, one galvanized steel water-cooling tank on tank-cooled engine, muffler, tool box, oil can, oil, and necessary tools. Batteries, spark coil, switch and wire furnished on 1-H. P. engine; other sizes can be started on magneto.

Special Accessories — Special size plain pulleys, friction clutch pulleys, etc., can be furnished on special order. See pages 28 to 32.

| Type of Engine | H. P. | Speed R. P. M. | Regular Pulley | | Flywheel | | Capacity of Hopper Gallons | Capacity of Fuel Tank Gallons | Base Measures Inches | | Approximate Shipping Weight Pounds |
|----------------|-------|----------------|-----------------|--------------------------------|--------------------------------|-------------------------------|----------------------------|-------------------------------|--------------------------------|--------------------------------|------------------------------------|
| | | | Diameter Inches | Face Inches | Diameter Inches | Face Inches | | | Width of Frame | Length of Frame | |
| Tank cooled | 1 | 450 | 12 | 3 ³ / ₈ | 33 | 2 ¹ / ₂ | 13 | 12 | 33 ⁵ / ₈ | 33 ¹ / ₂ | 1295 |
| Tank cooled | 6 | 390 | 16 | 12 ¹ / ₄ | 40 ¹ / ₂ | 2 ¹ / ₂ | 13 | 12 | 40 ¹ / ₄ | 40 ³ / ₄ | 1715 |
| Tank cooled | 8 | 375 | 18 | 10 ³ / ₄ | 45 | 3 | 23 | 15 | 43 ³ / ₄ | 45 ¹ / ₄ | 2310 |
| Tank cooled | 10 | 350 | 20 | 10 ¹ / ₄ | 49 ¹ / ₂ | 3 | 23 | 15 | 46 ¹ / ₄ | 49 ³ / ₄ | 2530 |
| Tank cooled | 12 | 300 | 24 | 11 ¹ / ₄ | 51 | 3 | 34 | 15 | 51 ³ / ₄ | 51 ¹ / ₄ | 3010 |
| Tank cooled | 15 | 275 | 26 | 12 ¹ / ₄ | 63 | 3 | 34 | 10 | 61 ⁷ / ₈ | 63 | 3985 |
| Tank cooled | 20 | 275 | 28 | 16 ¹ / ₄ | 60 | 3 ³ / ₄ | 34 | 12 | 61 ¹ / ₂ | 61 | 5005 |
| Hopper cooled | 1 | 450 | 12 | 3 ³ / ₈ | 33 | 2 ¹ / ₂ | 6 | 12 | 15 ¹ / ₄ | 33 ⁵ / ₈ | 1230 |
| Hopper cooled | 6 | 390 | 16 | 12 ¹ / ₄ | 40 ¹ / ₂ | 2 ¹ / ₂ | 12 | 12 | 17 | 10 ¹ / ₄ | 1665 |
| Hopper cooled | 8 | 375 | 18 | 10 ³ / ₄ | 45 | 3 | 16 | 15 | 20 | 43 ³ / ₄ | 2275 |
| Hopper cooled | 10 | 350 | 20 | 10 ¹ / ₄ | 49 ¹ / ₂ | 3 | 20 | 15 | 20 | 46 ¹ / ₄ | 2565 |
| Hopper cooled | 12 | 300 | 24 | 11 ¹ / ₄ | 51 | 3 | 22 | 15 | 21 ³ / ₄ | 51 ¹ / ₄ | 2800 |

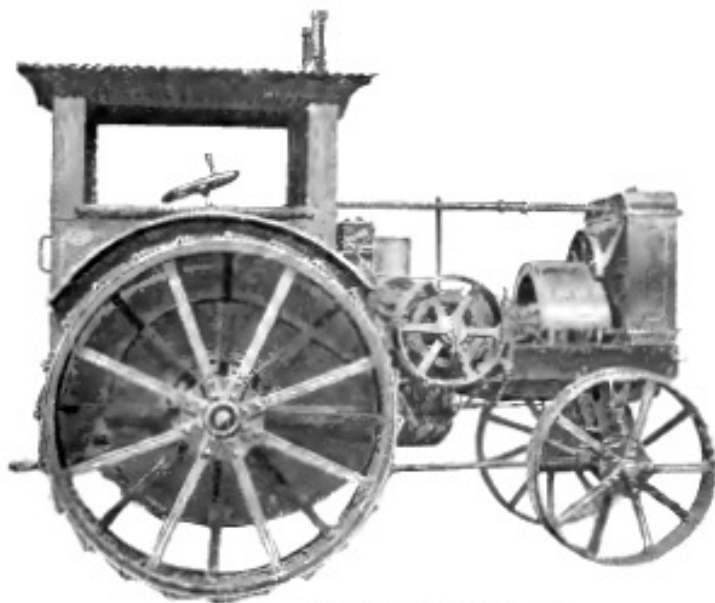

Titan 12-25 H. P. Oil Tractor

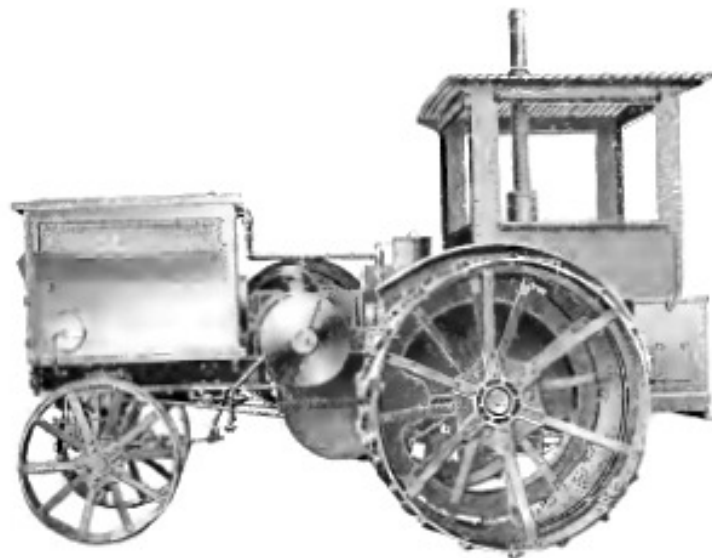

Titan 18-35 H. P. Oil Tractor

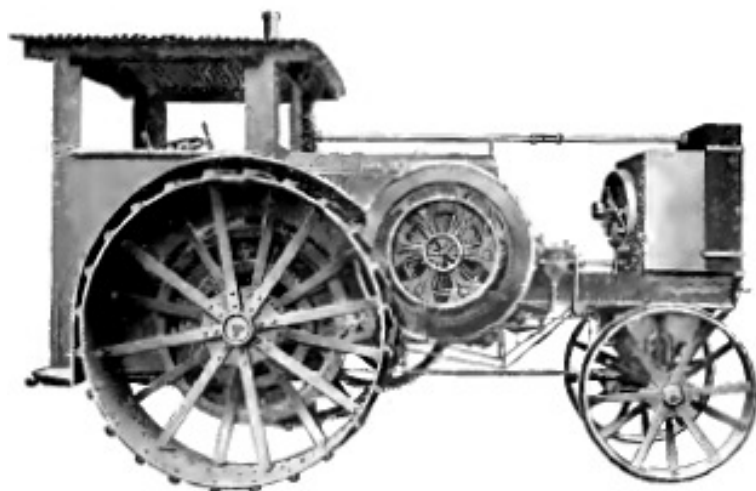

Titan 30-60 H. P. Oil Tractor

Titan 12-25 H. P. Tractor

The Titan 12-25 four cylinder oil tractor is the latest design light weight tractor for general farm use. Every refinement in equipment and design is included in this tractor. The cylinders are horizontal which gives this engine a great advantage on kerosene and low grade fuels. The transmission gives two speeds ahead and one reverse. The cooling is by auto truck type radiator, aided by an aluminum fan, and the water is circulated by a belt driven rotary pump. The frame is spring mounted on both forward and rear axles. The platform in the cab is also spring mounted on the frame. From the first tractor of this design put out, they have had a remarkable record for efficiency and low cost of upkeep. A comfortable cab and spring seat are provided for the operator.

Titan 18-35 H. P. Tractor

This is a moderate weight tractor for all around use on medium sized farms and for threshing or road work. The power plant is a horizontal twin cylinder oil burning engine completely enclosed from the dust and dirt, equipped with the latest type oiling devices, magneto, etc. This tractor has two speeds ahead and one reverse. A double gear drive to the rear wheel is used. The air starter is a great convenience especially in cold weather. The platform is spring mounted on the frame. A cab and spring seat are furnished for the operator's comfort.

Titan 30-60 H. P. Tractor

The Titan 30-60 H. P. oil tractor is designed for heavy farm or road work. This tractor is in use in all parts of the world under the most varied conditions and is well known for reliability and power. The power plant is a horizontal twin cylinder oil burning engine equipped with a U. H. P. engine starter. The transmission gives one speed ahead and one reverse. Gear drive is used. The platform is spring mounted to relieve the operator of the vibration when on the road. Equipped with large cab and comfortable spring seat.

TITAN
POWER

MAKES HARD WORK EASY AND

TITAN
POWER

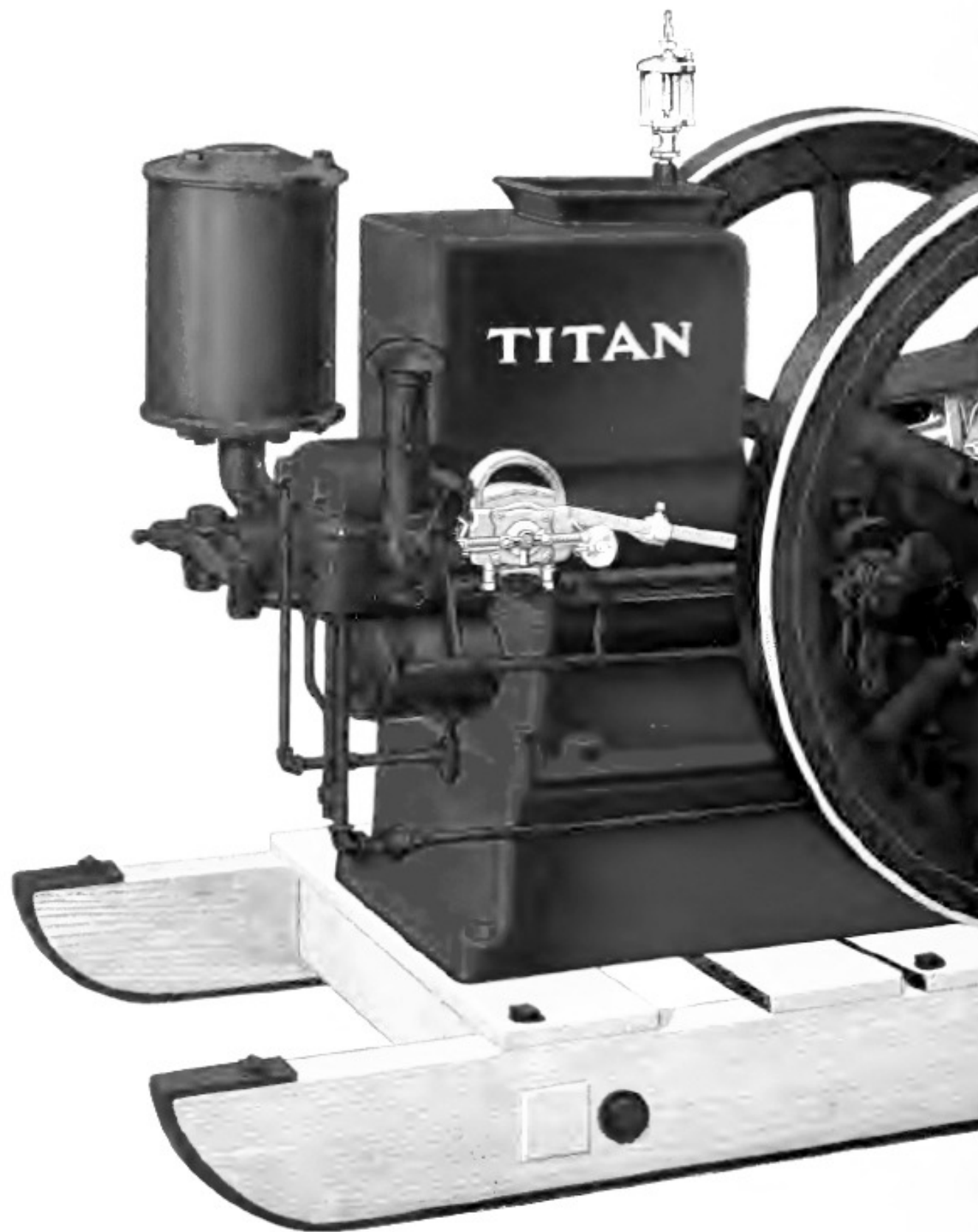

Oil Burning
Magneto Ignition
Slow Speed
Completely Equipped

Titan 6-H. P. Hopper-Cooled Oil Farm Engine

TITAN
POWER

SAVES MONEY ON EVERY JOB

TITAN
POWER

Titan Tilting Table Sawing Outfits

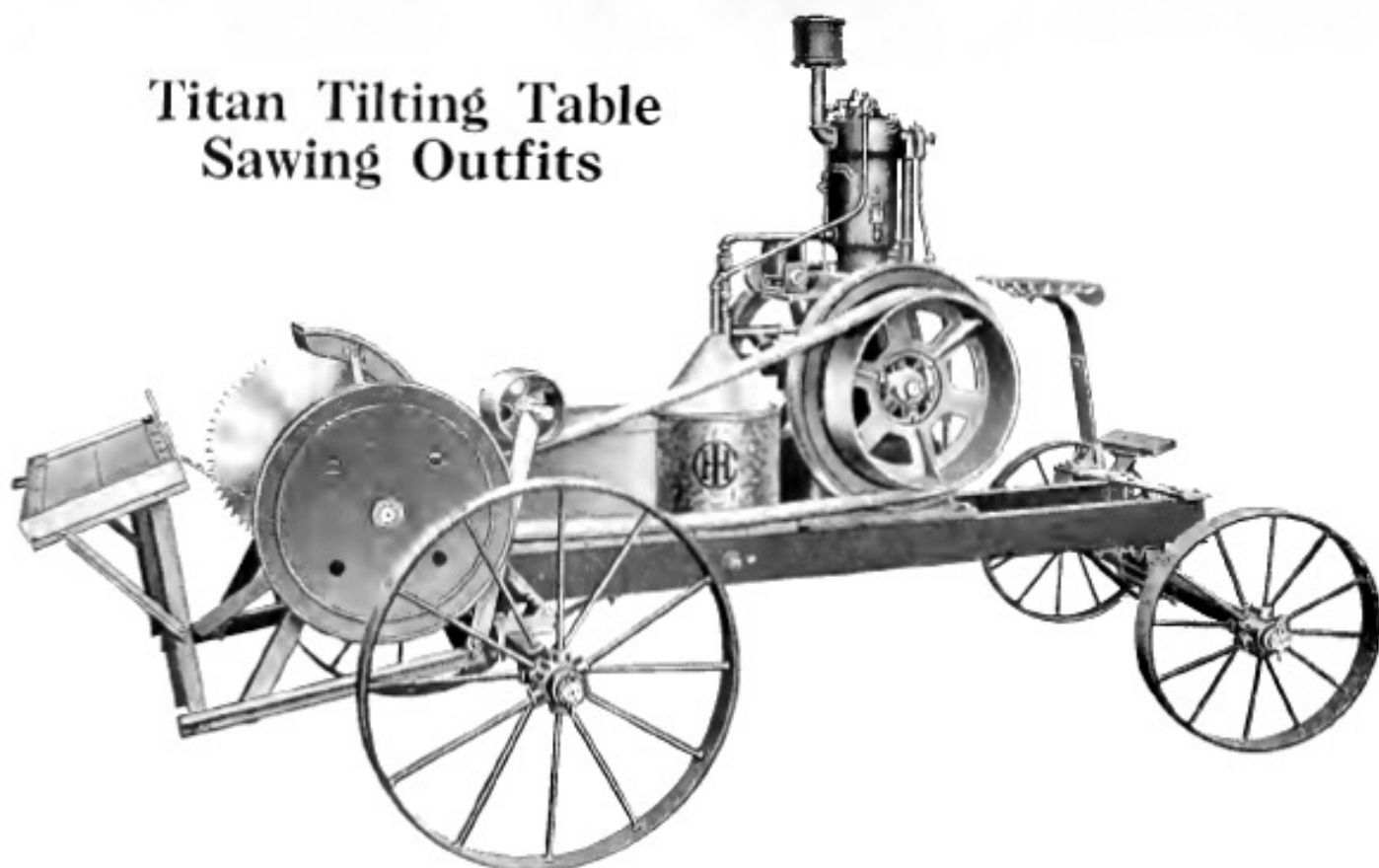

Titan 3-H. P. Tilting Table Saw Rig with Right Hand Table

The Titan 3-H. P. portable saw outfit is designed for the farmer who desires to saw his own wood. This outfit will handle soft wood up to 7 or 8 inches in diameter, or hard wood up to 4 or 5 inches in diameter, at the rate of about 2 cords per hour. The 4-H. P. outfit will handle soft wood up to 8 or 9 inches in diameter and hard wood up to about 6 inches in diameter at the rate of about 3 cords per hour. The 6-H. P. outfit will handle soft wood up to about 10 or 11 inches in diameter and hard wood up to about 7 or 8 inches in diameter at the rate of about 4 cords per hour.

These outfits are equipped with tilting

tables made in two types—right hand with the working table on the right, and left hand with the working table on the left. In ordering, state whether right hand or left hand table is wanted. A saw can be furnished at extra cost.

The engine can also be used as a portable engine or can be dismounted and used as a stationary engine. The 3-H. P. size is equipped with the engine on page 10 without the skids. The 4 and 6-H. P. sizes can be equipped with either of the following: Tank-cooled oil engine shown on page 13; hopper-cooled oil engine shown on page 13.

Equipment—Titan portable saw outfits are equipped complete, with the exception of the saw, with the following accessories: Complete engine equipment with plain pulley on 3-H. P. engine, friction clutch on 4 and 6-H. P. engines; belt, spring seat, pole, doubletree, and neckyoke.

Special Accessories—These include special sized plain and friction clutch pulleys, special mixers on 3-H. P. size, shafts in place of pole, etc. (see pages 23 to 32). Wheel braces and brake for the 4 and 6-H. P. sizes can be furnished.

| Engine H. P. | Size of Engine Pulley | | Diameter of Saw Pulley, Inches | Saw Diameter Recommended, Inches | Capacity of Water Tank, Gallons | Capacity of Fuel Tank, Gallons | Truck Measurements Inches | | | | | Approximate Shipping Weight Truck only, Pounds | Shipping Weight Complete, Pounds |
|--------------|-----------------------|-----------------|--------------------------------|----------------------------------|---------------------------------|--------------------------------|---------------------------|------------------|----------------------|---------------------|-----------------|--|----------------------------------|
| | Diameter Inches | Face Inches | | | | | Tread | Reach | Diameter Front Wheel | Diameter Rear Wheel | Width of Tires | | |
| 3 | 20 | 5 $\frac{1}{2}$ | 5 $\frac{1}{4}$ | 24 | 7 $\frac{1}{2}$ | 3 | 56 $\frac{1}{2}$ | 36 $\frac{1}{2}$ | 26 | 34 | 3 $\frac{1}{2}$ | 1090 | 2070 |
| 4 | 16 | 6 $\frac{1}{2}$ | 5 $\frac{1}{4}$ | 26 | 13 | 7 | 56 $\frac{1}{2}$ | 36 $\frac{1}{2}$ | 26 | 34 | 3 $\frac{1}{2}$ | 1090 | 2125 |
| 6 | 18 | 6 $\frac{1}{2}$ | 5 $\frac{1}{4}$ | 28 | 13 | 15 | 56 $\frac{1}{2}$ | 36 $\frac{1}{2}$ | 26 | 34 | 3 $\frac{1}{2}$ | 1090 | 2355 |

Titan Large Sawing Outfits

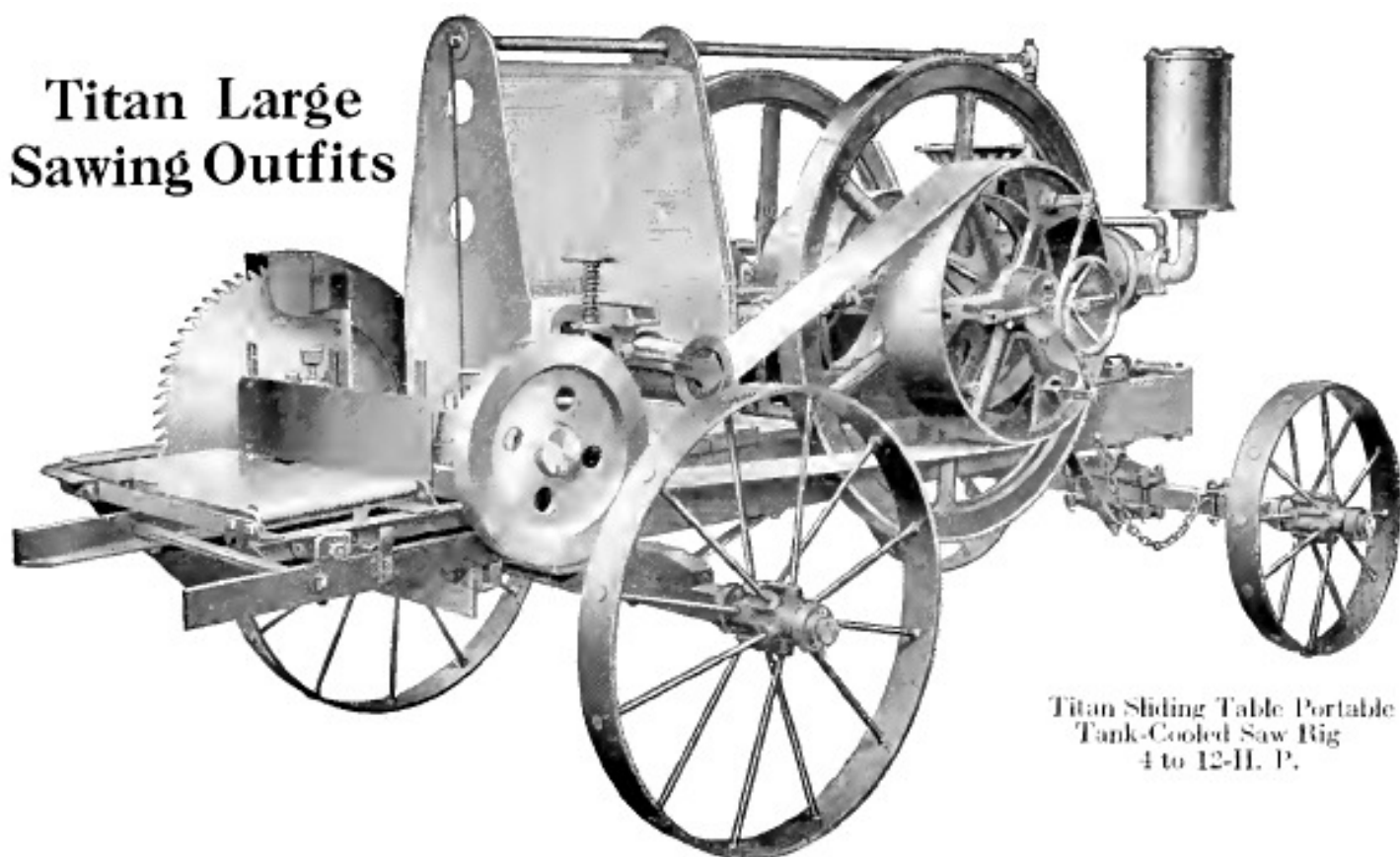

Titan Sliding Table Portable Tank-Cooled Saw Rig
4 to 12-H. P.

The Titan portable saw outfit is designed so that the saw table can be removed from the truck to make a portable engine. These outfits are made in 4, 6, 8, 10 and 12-H. P. sliding table, and 8, 10 and 12-H. P. tilting table, right hand only.

The engine is the regular Titan hopper-cooled or tank-cooled mounting engine described on page 18.

The strong point of this engine is its rating. While we always advise a customer to be sure that he is getting an engine large enough to

handle his work with ease, and to meet future needs, he can be sure when buying a Titan engine that he is getting full rated power, with a generous surplus, so that should the engine be momentarily overloaded it will not be stalled.

The trucks are steel, rigidly constructed to withstand the rough service of country roads. A spring seat is provided for the driver. A flywheel is supplied on the pulley end of the mandrel. No saw is supplied with this outfit unless ordered. When not needed for sawing, the engine can be used for other work.

Equipment — Titan large portable tank-cooled saw rigs are completely equipped, with the exception of the saw, and include the following accessories: Complete engine equipment with friction clutch pulley, tool box, belt, steel spring seat, pole, doubletrees, neckyoke and wheel braces.

Special Accessories — Special sized plain or friction clutch pulleys, brake, shafts on the 4 and 6-H. P. sizes in place of pole, etc. can be supplied on special order. (See pages 28 to 32.)

| H. P. | Oil Engine Speed R. P. M. | Size of Oil Engine Pulley Sliding Table Rig | | Diameter of Saw Pulley Inches | Diameter of Saw Recommended Inches | Truck Measurements Inches | | | | | Approximate Shipping Weight Pounds, Truck Only | Approximate Shipping Weight Complete, Pounds |
|-------|---------------------------|---|-----------------|-------------------------------|------------------------------------|---------------------------|------------------|----------------------|---------------------|-------------|--|--|
| | | Diameter Inches | Face Inches | | | Tread | Wheel Base | Diameter Front Wheel | Diameter Rear Wheel | Width Tires | | |
| 4 | 150 | 16 | 6 $\frac{1}{2}$ | 5 $\frac{5}{8}$ | 26 | 58 $\frac{1}{2}$ | 80 $\frac{3}{4}$ | 30 | 38 | 4 | 15-10 | 2835 |
| 6 | 390 | 18 | 6 $\frac{1}{2}$ | 5 $\frac{5}{8}$ | 28 | 58 $\frac{1}{2}$ | 80 $\frac{3}{4}$ | 30 | 38 | 4 | 15-10 | 3275 |
| 8 | 375 | 22 | 7 $\frac{1}{2}$ | 6 $\frac{5}{8}$ | 28 | 58 $\frac{1}{2}$ | 88 $\frac{1}{4}$ | 30 | 38 | 4 | 15-15 | 4010 |
| 10 | 350 | 24 | 7 $\frac{1}{2}$ | 6 $\frac{5}{8}$ | 28 | 58 $\frac{1}{2}$ | 88 $\frac{1}{4}$ | 30 | 38 | 4 | 15-15 | 4235 |
| 12 | 300 | 28 | 9 $\frac{1}{2}$ | 6 $\frac{5}{8}$ | 28 | 58 $\frac{1}{2}$ | 88 $\frac{1}{4}$ | 30 | 38 | 6 | 15-15 | 4755 |



Titan 2-H. P. Gasoline Pumping Engine

Titan Gasoline Pumping Engine

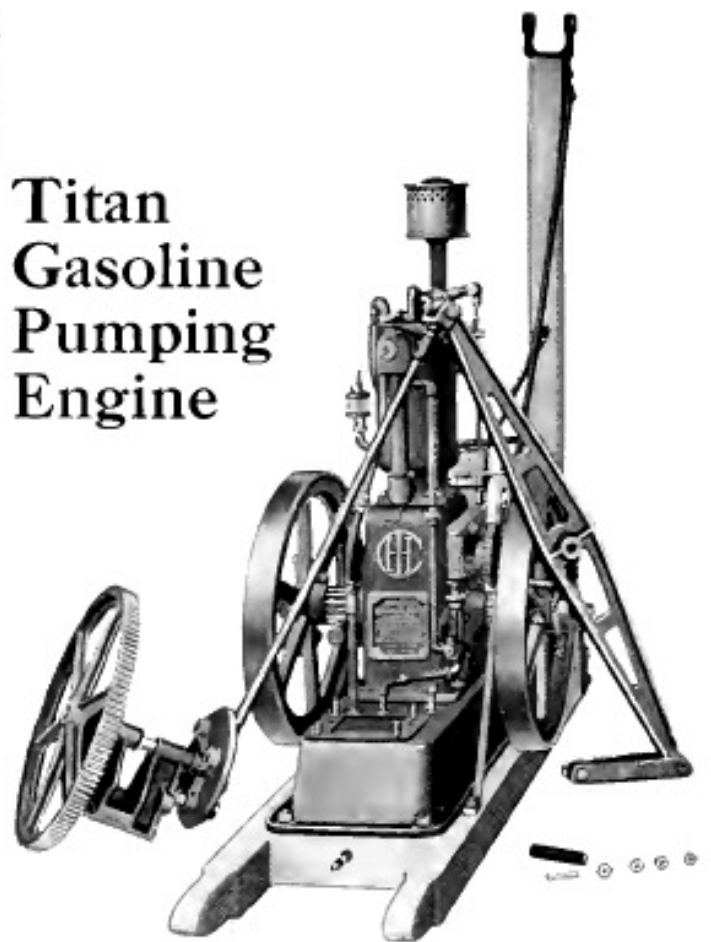

Titan 2-H. P. Gasoline Pumping Engine with Walking Beam Removed

The Titan gasoline 2-H. P. tank-cooled pumping outfit is a combined pump jack and engine, mounted on the same base, that can be used both for pumping and for other work. By detaching the walking beam from the engine (see above illustration) this outfit becomes similar to our regular Titan 2-H. P. vertical engine. It is mounted on skids and can be easily transported from place to place. The engine is the same in every respect as the Titan gasoline 2-H. P. vertical engine except that the iron sub-base is extended to form a base for the pumping gears, and a small pinion is added on the crank shaft for driving the pumping gear. It is regularly equipped to

operate on gasoline, motor spirit, benzine, or naphtha, but on special order can be equipped for alcohol. This outfit is especially desirable on stock farms, ranches, dairy farms, etc., where a large amount of water must be pumped and where an engine large enough for grinding feed, etc., is needed. It can be directly connected to a windmill pump and will furnish all the water needed on an ordinary farm.

The walking beam and gears are strongly constructed to stand the strain of deep-well pumping. The pitman stroke is adjustable to either 5, 7, or 10 inches. A description of the engine construction will be found on pages 33 to 35.

Equipment — Titan 2-H. P. pumping engines are completely equipped and include the following necessities: Galvanized fuel tank, galvanized cooling tank, belt pulley, muffler, magneto, tool box, necessary tools, oil can, and oil.

Special Accessories — Special size pulleys, friction clutch pulleys, special mixers, etc., can be furnished on special order. See pages 34 to 38.

| H. P. | Speed R.P.M. | Strokes Pump per Min. | Length of Stroke, Inches | Gear Number of Teeth | Pinion Number of Teeth | Capacity Fuel Tank, Gallons | Length Walking Beam, Inches | Height Walking Beam, Inches | Length of Skids, Inches | Width Total Skids, Inches | Total Width Inches | Regular Pulley | | Approximate Shipping Weight Pounds |
|-------|--------------|-----------------------|--------------------------|----------------------|------------------------|-----------------------------|-----------------------------|-----------------------------|-------------------------|---------------------------|--------------------|----------------|-------------|------------------------------------|
| | | | | | | | | | | | | Dia. Inches | Face Inches | |
| 2 | 100 | 18 1/2 | 5-7-10 | 121 | 15 | 3 1/4 | 56 | 71 3/8 | 68 | 18 1/4 | 32 1/2 | 8 | 5 | 1077 |

Titan 2-H. P. Pumping Outfit

Titan 1-H. P. Pumping Outfit

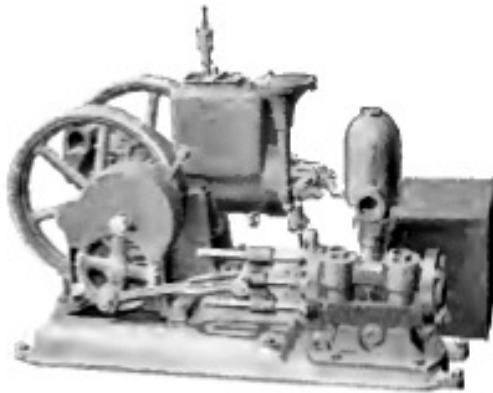

Titan 1-H. P. Combined Pumping Outfit

Titan combined pumping outfits are very compact and adapted for use in wet places where the damp atmosphere would injure a belt; for domestic water works where the suction lift is not over twenty feet, and are extensively used for pumping into elevated tanks for domestic water use, and in small factories for fire protection. Contractors also find them convenient for pumping from caissons, foundations, etc.

The smaller outfit consists of the regular Titan 1-H.P. hopper-cooled gasoline engine shown on page 3 geared to a Myers No. 456 double-acting force pump and both mounted

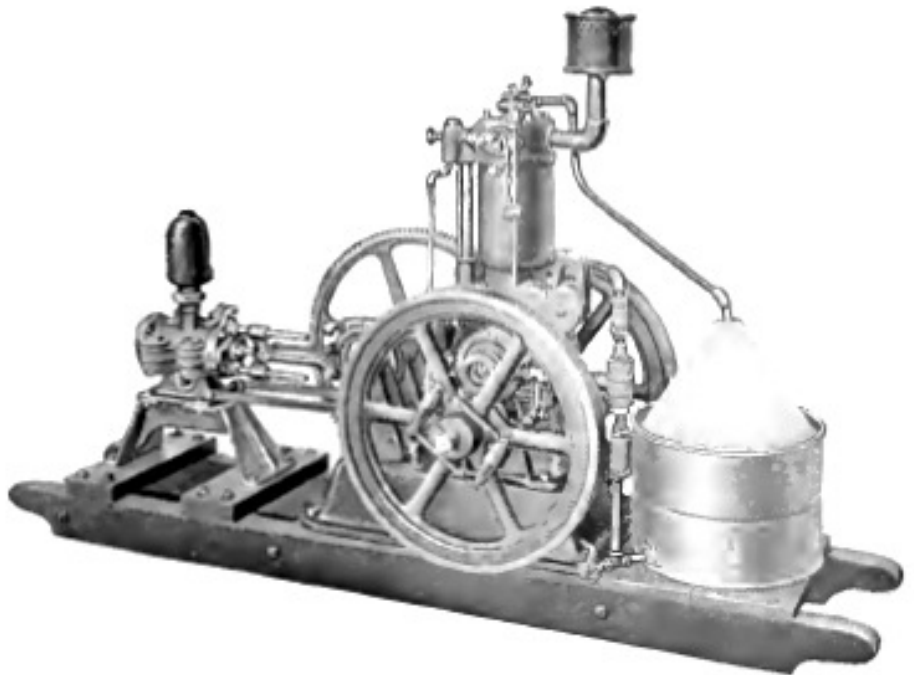

Titan 2-H. P. Combined Pumping Outfit

on a cast iron bed plate. This pump has a brass lined cylinder, brass valve seats and brass valves rubber faced. The suction pipe can be attached on either side, the valves are located under individual caps and can be removed without disturbing any other parts. The complete outfit is mounted on a substantial wood skid with battery box and complete equipment. No belt pulley or skids furnished.

The larger outfit consists of the Titan 2-H.P. vertical gasoline engine shown on page 10, geared to a Myers No. 456 double-acting force pump and the complete outfit mounted on substantial wood skids. No belt pulley furnished.

Equipment—The equipment is complete, except no belt pulleys are furnished. See page 3 for description and equipment on 1-H. P. engine and page 10 for 2-H. P. engine.

Special Accessories—Pulleys and many other special accessories can be furnished on special order. See pages 28 to 31.

| H. P. | PUMP | | | | | | Approximate Weight Pounds |
|-------|------------------------------|--------------------|--------------------|-------------------------------|--|----------------------------|---------------------------|
| | Diameter of Cylinder, Inches | Pump Stroke Inches | Strokes per Minute | Suction and Discharge, Inches | Approximate Capacity, Gals. per Minute | Maximum Working Head, Feet | |
| 1 | 3 | 5 | 49 | 1 1/4 | 7.3 | 150 | 490 |
| 2 | 3 | 5 | 48 1/2 | 1 1/4 | 7.3 | 300 | 1020 |

Titan Skidded Spraying Outfits



Titan 1-H. P. Air-Cooled Spraying Outfit

1-H. P. Air-Cooled Spraying Outfit

This outfit includes the "Tom Thumb" 1-H. P. air-cooled engine and Myers pump. It is especially adapted for use where a comparatively light outfit is necessary, and will take care of small and medium sized orchards. It is completely equipped with two lines of spray hose, suction hose, nozzles, etc., and mounted on a substantial wood base.

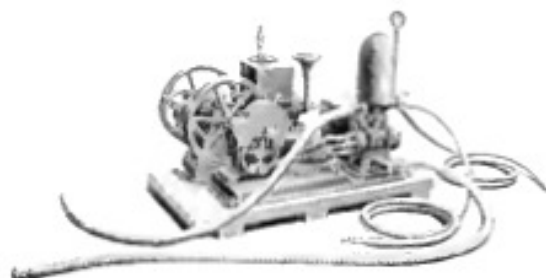

Titan 1-H. P. Hopper-Cooled Spraying Outfit

1-H. P. Hopper-Cooled Spraying Outfit

The Titan 1-H. P. hopper-cooled outfit includes the regular Titan 1-H. P. hopper-cooled engine and Myers spray pump. This is a very reliable outfit for all small and medium sized orchards, and will give the best of satisfaction. The equipment is complete, including two lines of spray hose, suction hose and nozzles. The complete outfit is mounted on wood platform, as shown in cut.



Titan 2 1/2-H. P. Spraying Outfit with Myers Pump

2 1/2-H. P. Spraying Outfit (Myers Pump)

This outfit is well adapted to large orchards and vineyards where high pressure up to 200 pounds must be maintained. It is large enough to handle any class of spray work. The engine is a Titan 2 1/2-H. P. hopper-cooled, geared to a Myers two-cylinder vertical pump. Complete equipment is included with two lines of spray hose, nozzles, and suction hose. Mounted on skids, as shown in cut.

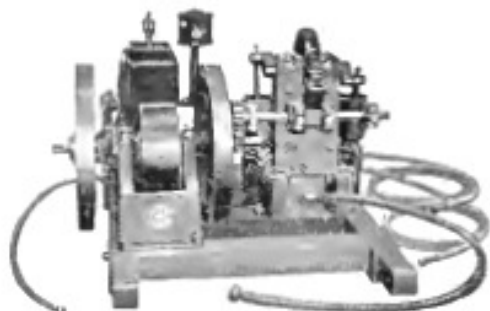

Titan 2 1/2-H. P. Lucas Spraying Outfit

2 1/2-H. P. Spraying Outfit (Lucas Pump)

For large spraying operations this is a very desirable outfit for large orchards and vineyards. The engine is the regular Titan 2 1/2-H. P. hopper-cooled, geared to a Lucas two-cylinder vertical pump. The pump is built exceptionally heavy for high pressure work. The equipment is complete, including two lines of spray hose, nozzles and suction hose. Mounted complete on skids.

Send for special Spraying Catalogue showing these outfits

Titan Portable Spray Outfits



Titan 1-H. P. Portable Air-Cooled Spraying Outfit

1-H. P. Portable Air-Cooled Spraying Outfit

This outfit is very desirable for small work, and can be more easily handled than the heavier outfits. The outfit includes the regular "Tom Thumb" 1-H. P. air-cooled engine, geared to a Myers pump and mounted on a special four-wheel truck. Two lines of spray hose, spray nozzles and suction hose are included. No barrel is furnished.

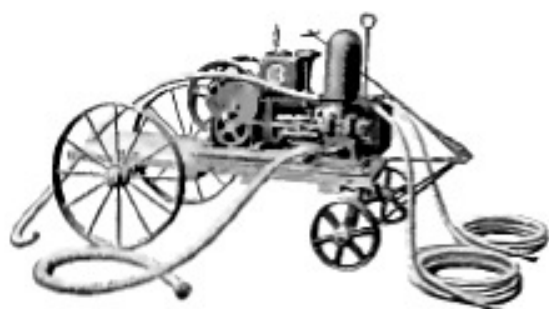

Titan 1-H. P. Portable Hopper-Cooled Spraying Outfit

1-H. P. Portable Hopper-Cooled Spraying Outfit

The 1-H. P. hopper-cooled portable spray rig includes the regular Titan 1-H. P. hopper-cooled engine geared to a Myers spray pump and mounted on a special four-wheel hand truck. This outfit is complete, except barrel, and is equipped with two lines of spray hose, spray nozzles, and suction hose.

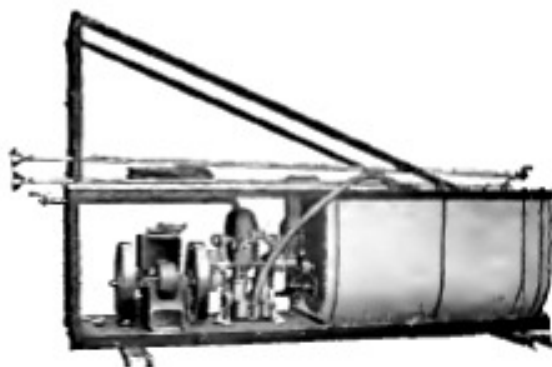

Titan 1-H. P. Complete Spraying Outfit

Complete 1-H. P. Spraying Outfit

This outfit comes complete ready to mount on a wagon truck. It is the ideal outfit for small and medium size orchards and vineyards and is a very desirable outfit to use where the ground is soft or sandy. It includes the regular 1-H. P. Titan hopper-cooled engine geared to a Myers two-cylinder vertical pump, mounted complete on steel sills with the spray tank and tower. Complete equipment is furnished including two lines of spray hose, spray nozzles and suction hose.

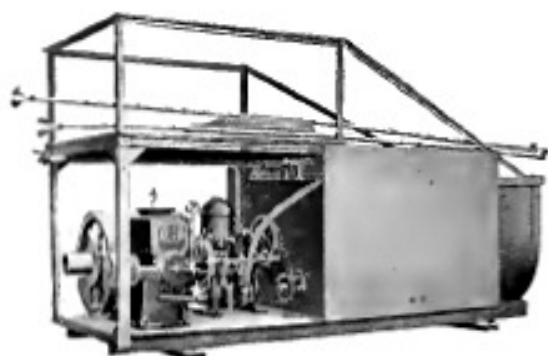

Titan 2 1/2-H. P. Complete Spraying Outfit

Complete 2 1/2-H. P. Spraying Outfit

The Titan 2 1/2-H. P. complete spraying outfit is designed for large work, and will give all the pressure needed for any class of spray work. It includes the Titan 2 1/2-H. P. hopper-cooled engine geared to a Myers two-cylinder vertical pump and mounted complete on steel sills with a spray tank and tower. The equipment is complete, and includes two lines of spray hose, spray nozzles, and suction hose.

Send for special Spraying Catalogue showing these outfits

Security Long Distance Gasoline Supply

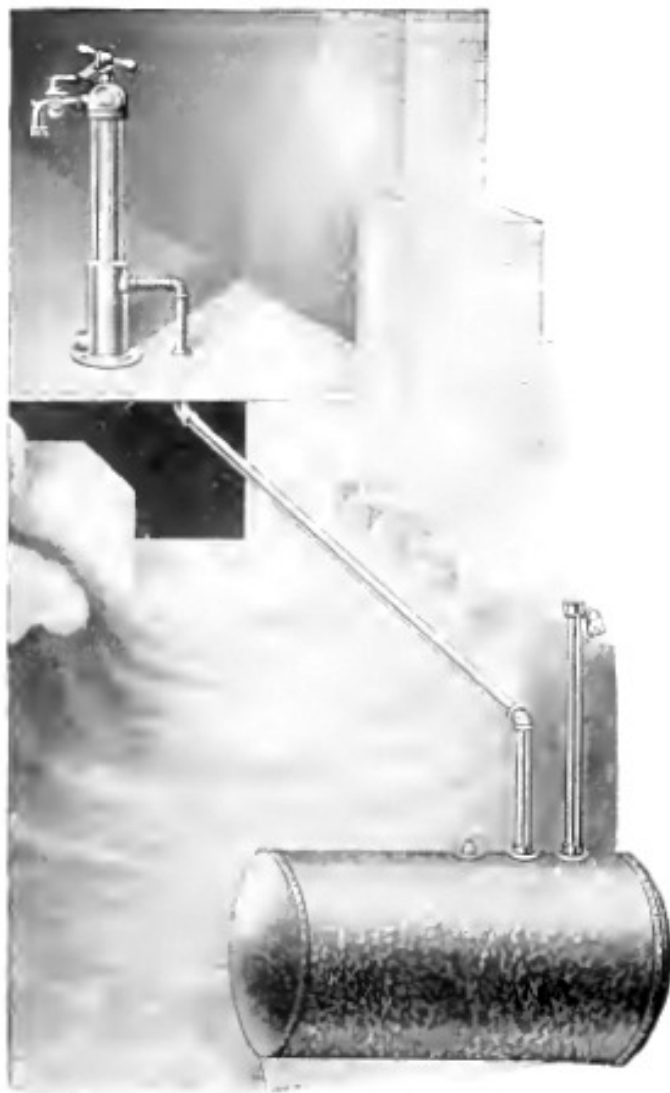

Method of Installation

This gasoline supply system is approved by the Underwriters Association and provides the safest and most satisfactory arrangement for storing and pumping gasoline. By burying the tank in the ground the gasoline can be kept cool so that the evaporation is reduced to a minimum.

This outfit, as shipped, consists of a 54-gallon tank or a 120-gallon tank, as desired, and pump, together with two bundles of 1-inch galvanized pipe and necessary couplings to connect it, and two padlocks—one for the pump and one for the filling cap.

Shipping weight, complete with 54-gallon tank, 162 lbs.

Shipping weight, complete with 120-gallon tank, 212 lbs.

Pump Jacks

Standard Jack No. 1—
This jack is designed to attach direct to the standard of any common windmill pump and will pump all the water needed on the ordinary farm. It is clamped to the pump and bolted to the well cover or pump foundation.



Standard Pump Jack No. 1



Standard Pump Jack No. 2

Standard Jack No. 2—
The Standard No. 2 jack is similar to the No. 1, but is built heavier and is suitable for pumping from wells up to 200 ft. deep.

It is used extensively on ranches, stock farms, and dairy farms. Like No. 1 it can be attached to a common windmill pump. This jack is strongly constructed of iron with heavy cast double gears and will give the best of service.

| Type of Jack | Length of Stroke, Inches | Strokes per Minute | Pulley | | | Weight, Pounds |
|--------------|--------------------------|--------------------|------------------|-----------------|--------------|----------------|
| | | | Size Inches | Face Inches | Speed R.P.M. | |
| No. 1. | 5, 7, 9, 11 | 40 | 14 $\frac{1}{4}$ | 2 $\frac{1}{2}$ | 230 | 120 |
| No. 2. | 5, 7, 9, 11 | 40 | 14 $\frac{1}{4}$ | 2 $\frac{1}{2}$ | 230 | 139 |

Pump Jacks

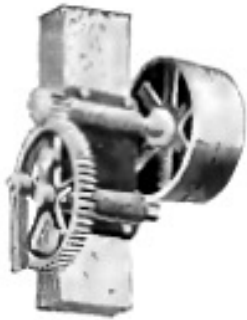

Regular Belted Jack

Regular Belted Jack—This jack is suitable for ordinary farm pumping, where the lift is not high and the work is not heavy, and light irrigation work. It is well made with long bearings and heavy cast gears.

Walking Beam Jack No. 1—This jack is all iron except the base. It should not be used for pumping against greater than a 100-foot head with a 2¼-inch cylinder. It is designed for ordinary farm pumping. The jack is well constructed from the best grade of materials, and with proper care should last a lifetime.



Walking Beam Jack No. 1

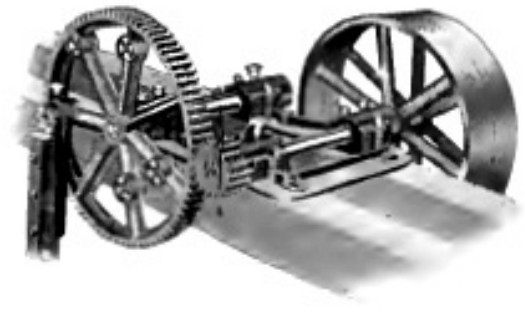

Heavy Belted Jack

Heavy Belted Jack—The heavy belted pumping jack is an excellent jack for use in lifting water in wells not deeper than 400 feet. It is considerably heavier than the regular jack and has unusual strength and durability. It is designed to be used with engines up to and including 12-horse power. Stockmen and farmers who have deep wells find this heavy jack very desirable.

Walking Beam Jack No. 2—This walking beam pumping jack is a heavier jack than the No. 1 and can be used to lift water in wells not deeper than 200 feet. It is constructed of iron except the base and upright, which are of wood. The safe working load on the end of the walking beam is 1,200 lbs., which is equivalent to a 4½-in. cylinder pumping against a 200-foot head.

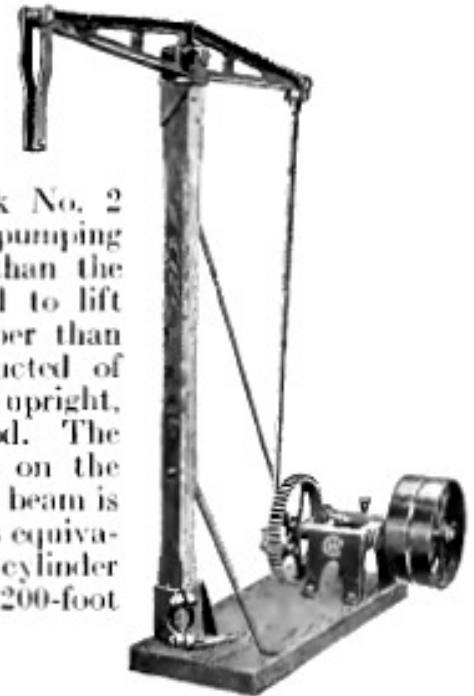

Walking Beam Jack No. 2

| Type of Pump Jack | Minimum Head, Feet | Length of Stroke, Inches | Strokes per Minute | Size of Engine to be used with | Ratio of Gears | Pulley | | | Weight Pounds |
|---------------------|--------------------|--------------------------|--------------------|--------------------------------|----------------|-------------|-------------|--------------|---------------|
| | | | | | | Size Inches | Face Inches | Speed R.P.M. | |
| Walking Beam No. 1 | 100' with 2¼" Cyl. | 5 to 9¾ | 40 | 1 to 2-H. P. | 7.1 to 1 | 13¾ | 2¾ | 285 | 152 |
| Walking Beam No. 2 | 200' with 4½" Cyl. | 5, 7, 10 | 40 | 2 to 3-H. P. | 4.66 to 1 | 14 | 3 | 185 | 303 |
| Regular Belted Jack | 200' with 4½" Cyl. | 5, 7, 10 | 40 | 1 to 3-H. P. | 4.66 to 1 | 14 | 3 | 185 | 145 |
| Heavy Belted Jack | 100' | 12, 14, 15, 18, 20 | 32 | 4 to 12-H. P. | 5. to 1 | 24 | 4½ | 160 | 515 |

When pump jacks are used to pump with a smaller head, the size of the pump cylinder can be increased.

Two-Wheel Hand Truck

Attachment for Titan
1-H. P. Engines



1-H. P. Engine Truck

This truck consists of an iron handle, front wheels and axle and can be supplied for Titan or "Tom Thumb" 1-H. P. engines in the field or can be shipped with the engine from the factory. The axle is located so that when the end is lifted by the handles the outfit nearly balances and can be used like an ordinary hand truck. It is strongly constructed with heavy cast iron wheels and an iron axle for use where an engine is used to operate small machines at different points on the farm.



2-H. P. Vertical Skidded Engine Mounted on Truck

Four-Wheel Hand Truck

Attachment for Titan 2, 2½ and 3-H. P.
Engines

Nonpareil Type 2, 3, 4 and 6-H. P.
Engines

This truck consists of rear axle with wheels and clips, and front axle with wheels, clips and tongue. It can be furnished for Titan 2 and 3, and Nonpareil 2, 3, 4 and 6-H. P. vertical and Titan 2½-H. P. horizontal skidded engines, in the field, or can be shipped with engines from the factory. It is substantially constructed with four heavy cast iron wheels and axles with iron hand tongue. The same truck is used for all 2, 2½, 3 and 4-H. P. sizes and a larger and heavier truck is furnished for 6-H. P. engine.

Four-Wheel Hand Truck

Attachment for Titan Skidded 4, 6, 8, 10
and 12-H. P. Engines



Large Four-Wheel Truck Mounted on Engine Skids

The truck consists of rear axle with wheels, front axle with wheels, hand tongue, and four 5/8-inch square-head bolts. Upon each axle held by a "U" bolt are two castings slotted to fit over the heads of the bolts in the skid, and when so placed, hold the truck in position. This truck can be placed under any 4, 6, 8, 10, or 12-H. P. Titan skidded engine skid now in the field by boring four 5/8-inch holes through the wooden skid runners or can be shipped from the factory with engine.

Diameter of wheels, 25½ inches. Face of wheels, 3 inches. Shipping weight, about 550 pounds.

Gas Mixers

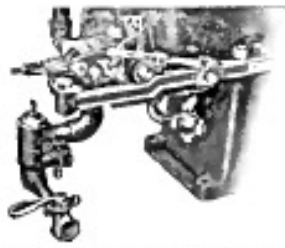

Titan 1-H. P. Gas Mixer

Gas Mixer—Titan vertical engines and 1 and 2½-H. P. hopper-cooled engines can be supplied with a gas attachment, which is easily attached in place of the gasoline mixer, on special order. With this attachment, natural gas may be used as fuel with excellent results.

When artificial gas is to be used, it is necessary to change the entire cylinder head and piston, except on the 1-H. P. engines. Therefore, when artificial gas is to be used it should be so stated when ordering the engine.

Combination Mixers for Gas and Gasoline



A combination gas and gasoline attachment is furnished on special order for the Titan vertical tank-cooled engines, and 2½-H. P. horizontal hopper-cooled engines. This attachment has been designed especially for use in localities where natural gas is available part of the time.

The change from one fuel to another may be made instantly and without stopping the engine.

Extended Crank Shafts

Either or both sides furnished on special order:

| Engine | Exten. | Diam. | Key Way in Shaft |
|----------------------------|--------|--------|-------------------------|
| 1-H. P. Hor. Air-C'ld. | 4" | 1 1/8" | 3/16" wide x 3/8" deep |
| 1-H. P. Hor. Hop.C'ld. | 4" | 1 1/8" | 3/16" wide x 3/8" deep |
| 2-H. P. Ver. Tk.-C'ld. | 4 3/4" | 1 7/8" | 3/16" wide x 3/8" deep |
| 2 1/2-H. P. Hor. Hp.-C'ld. | 4 3/4" | 1 1/2" | 3/16" wide x 3/8" deep |
| 3-H. P. Ver. Tk.-C'ld. | 4 3/4" | 1 9/8" | 3/16" wide x 3/8" deep |
| 4-H. P. Hor. | 4 3/4" | 2 1/8" | 3/16" wide x 3/8" deep |
| 6-H. P. Hor. | 4 3/4" | 2 3/8" | 3/16" wide x 3/8" deep |
| 8-H. P. Hor. | 5 1/2" | 2 3/8" | 3/8" wide x 1/4" deep |
| 10-H. P. Hor. | 6" | 2 3/8" | 1 1/8" wide x 3/8" deep |
| 12-H. P. Hor. Tank-C. | 6" | 2 3/8" | 5/4" wide x 1/4" deep |
| 15-H. P. Hor. Tank-C. | 6 1/2" | 2 3/8" | 1 1/2" wide x 1/4" deep |
| 20-H. P. Hor. Tank-C. | 8" | 3 3/8" | 1 7/8" wide x 3/8" deep |
| 25-H. P. Hor. Tank-C. | 8" | 4 1/8" | 1 1/4" wide x 1/2" deep |

Magneto for Tom Thumb



The Wizard magneto can be furnished extra for Tom Thumb engines. It is driven by friction contact with the flywheel of the engine. It can be easily attached by any

one. Batteries must be used for starting.

Alcohol Mixers

Alcohol attachments may be furnished for vertical tank-cooled engines, and 2½-H. P. horizontal hopper-cooled engines. This attachment consists of a new cylinder head complete, an alcohol mixer, and a strainer. This alcohol attachment is furnished as an extra only on special order.



Reducing Gears



A reducing gear can be furnished on special order extra for the 1 or 2½-H. P. engines and can be shipped with the engine or attached in the field. It is designed for operating cream separators, churns, etc. A combined bracket for

magneto and reducing gear can be furnished for 1-H. P. engines.

| ENGINE | | | PULLEY | | |
|--------------------|-------|-------|---------|----------|-----------|
| H. P. | Speed | Diam. | Face | H. P. M. | Eq. P. M. |
| 1-H. P. | | | | | |
| Air and Hopper | 600 | 4" | 2 3/16" | 150 | 157 |
| 2 1/2-H. P. Hopper | 500 | 3" | 2 3/16" | 199 | 156 |

TITAN POWER FOR THE FARM

Nonpareil Special Plain Pulleys

| 2 H. P. | | 3 H. P. | | 4 H. P. | | 6 H. P. | |
|--------------|-------------|--------------|-------------|--------------|-------------|--------------|-------------|
| Diam. Inches | Face Inches | Diam. Inches | Face Inches | Diam. Inches | Face Inches | Diam. Inches | Face Inches |
| 4 | 5 1/2 | 3 | 5 | 4 | 5 1/2 | 6x7 1/4 | 12 |
| 5 | 5 1/2 | 4 | 5 | 5 | 5 1/2 | 10 | 3 5/8 |
| 7 | 5 1/2 | 5 | 5 | 7 | 5 1/2 | 10 | 12 1/4 |
| 8 | 5 1/2 | 5x9 | 9 | 8 | 5 1/2 | 12 | 3 3/8 |
| 8 | 5 1/2 | 7x5 | 5 | 8 | 5 1/2 | 12 | 12 1/4 |
| 9 | 5 1/2 | 9 | 5 | 9 | 5 1/2 | 11 | 3 3/8 |
| 10 | 5 1/2 | 10 | 5 | 10 | 5 1/2 | 11 | 12 1/4 |
| 12 | 5 1/2 | 12 | 5 | 12 | 5 1/2 | 16 | 12 1/4 |
| 14 | 5 1/2 | 14 | 5 | 14 | 5 1/2 | 18 | 10 1/4 |
| 16 | 5 1/2 | 16 | 5 | 16 | 5 1/2 | 20 | 10 1/4 |
| | | 18 | 5 | 18 | 5 1/2 | 22 | 10 1/4 |
| | | 20 | 5 | 20 | 5 1/2 | 24 | 9 1/2 |
| | | | | | | 26 | 9 1/2 |
| | | | | | | 28 | 9 1/2 |
| | | | | | | 30 | 9 1/2 |

Nonpareil Special Friction Clutch Pulleys

| 2 H. P. | | 3 H. P. | | 4 H. P. | | 6 H. P. | |
|--------------|-------------|--------------|-------------|--------------|-------------|--------------|-------------|
| Diam. Inches | Face Inches | Diam. Inches | Face Inches | Diam. Inches | Face Inches | Diam. Inches | Face Inches |
| 10 | 4 1/2 | 10 | 4 1/2 | 10 | 4 1/2 | 14 | 6 1/2 |
| 12 | 4 1/2 | 12 | 4 1/2 | 12 | 4 1/2 | 16 | 6 1/2 |
| 14 | 4 1/2 | 14 | 4 1/2 | 14 | 4 1/2 | 18 | 6 1/2 |
| 16 | 4 1/2 | 16 | 4 1/2 | 16 | 4 1/2 | 20 | 6 1/2 |
| | | 18 | 4 1/2 | 18 | 4 1/2 | 22 | 6 1/2 |
| | | 20 | 4 1/2 | 20 | 4 1/2 | 24 | 6 1/2 |
| | | 22 | 4 1/2 | 22 | 4 1/2 | 26 | 6 1/2 |
| | | | | | | 28 | 6 1/2 |
| | | | | | | 30 | 6 1/2 |

Note—A six-tooth sprocket can be supplied for the 2-H. P. Nonpareil engine to take a Chain Belt Co.'s No. 62 chain.

Special Sizes of Plain Pulleys for Titan Vertical and 2 1/2-H. P. Horizontal Engines

| Diameter | Face | |
|-----------|--------------------------|--|
| | 2 H. P. Ver. Tank-Cooled | 2 1/2 H. P. Hor. Hopper-Cooled 3 H. P. Ver. Tank-Cooled |
| 3 inches | 5 inches | 5 1/2 inches |
| 4 inches | 5 inches | 5 1/2 inches |
| 5 inches | 9 inches or 5 inches | 5 1/2 inches |
| 6 inches | | |
| 7 inches | 5 inches | 5 1/2 inches |
| 8 inches | 5 inches | 7 1/2 or 5 1/2 inches |
| 9 inches | 5 inches | 5 1/2 inches |
| 10 inches | 5 inches | 5 1/2 inches |
| 12 inches | 5 inches | 5 1/2 inches |
| 14 inches | 5 inches | 5 1/2 inches |
| 16 inches | 5 inches | 5 1/2 inches |
| 18 inches | *5 inches | *5 1/2 inches |
| 20 inches | *5 inches | *5 1/2 inches |

Friction Clutch Pulleys for Titan 2 and 3-H. P. Vertical Tank-Cooled, and 2 1/2-H. P. Hopper-Cooled

| 2 H. P. Vertical Tank-Cooled | | 3 H. P. Vertical Tank-Cooled 2 1/2 H. P. Horiz. Hopper-Cooled |
|------------------------------|--------|--|
| Diameter | Face | |
| 10 | 4 1/2 | 4 1/2 |
| 12 | 4 1/2 | 4 1/2 |
| 14 | 4 1/2 | 4 1/2 |
| 16 | 4 1/2 | 4 1/2 |
| 18 | *4 1/2 | *4 1/2 |
| 20 | *4 1/2 | *4 1/2 |
| 22 | *4 1/2 | *4 1/2 |

*18, 20 and 22-inch diameter pulleys furnished for tank-cooled engine only.

Note—A six-tooth sprocket can be supplied for the 3-H. P. vertical and 2 1/2-H. P. horizontal engines to take a Chain Belt Co.'s No. 62 chain.

Special Pulleys for Titan Horizontal Engines, 4 to 25-H. P.

| Friction Pulley—Width of Face, Inches | | | | | | | | | Plain Pulley—Width of Face, Inches | | | | | | | | |
|---------------------------------------|---------|---------|---------|----------|----------|----------|----------|----------|------------------------------------|---------|---------|---------|----------|----------|----------|----------|----------|
| Dia. | 4 H. P. | 6 H. P. | 8 H. P. | 10 H. P. | 12 H. P. | 15 H. P. | 20 H. P. | 25 H. P. | Dia. | 4 H. P. | 6 H. P. | 8 H. P. | 10 H. P. | 12 H. P. | 15 H. P. | 20 H. P. | 25 H. P. |
| 6 | 6 | 6 | 6 | 6 | 6 | 6 | 6 | 6 | 6 | 7 1/2 | 7 1/2 | 12 | 12 | | 8 | 8 | 8 |
| 8 | 6 | 6 | 6 | 6 | 6 | 6 | 6 | 6 | 8 | 12 | 12 | 12 | 12 | | 10 | 10 | 10 |
| 10 | 6 | 6 | 6 | 6 | 6 | 6 | 6 | 6 | 8 | 10 | 10 | 10 | 10 | | 12 | 12 | 12 |
| 12 | 6 | 6 | 6 | 6 | 6 | 6 | 6 | 6 | 8 | 10 | 10 | 10 | 10 | | 14 | 14 | 14 |
| 14 | 6 | 6 | 6 | 6 | 6 | 6 | 6 | 6 | 8 | 10 | 10 | 10 | 10 | | 16 | 16 | 16 |
| 16 | 6 | 6 | 6 | 6 | 6 | 6 | 6 | 6 | 8 | 10 | 10 | 10 | 10 | | 18 | 18 | 18 |
| 18 | 6 | 6 | 6 | 6 | 6 | 6 | 6 | 6 | 8 | 10 | 10 | 10 | 10 | | 20 | 20 | 20 |
| 20 | 6 | 6 | 6 | 6 | 6 | 6 | 6 | 6 | 8 | 10 | 10 | 10 | 10 | | 22 | 22 | 22 |
| 22 | 6 | 6 | 6 | 6 | 6 | 6 | 6 | 6 | 8 | 10 | 10 | 10 | 10 | | 24 | 24 | 24 |
| 24 | 6 | 6 | 6 | 6 | 6 | 6 | 6 | 6 | 8 | 10 | 10 | 10 | 10 | | 26 | 26 | 26 |
| 26 | 6 | 6 | 6 | 6 | 6 | 6 | 6 | 6 | 8 | 10 | 10 | 10 | 10 | | 28 | 28 | 28 |
| 28 | 6 | 6 | 6 | 6 | 6 | 6 | 6 | 6 | 8 | 10 | 10 | 10 | 10 | | 30 | 30 | 30 |
| 30 | 6 | 6 | 6 | 6 | 6 | 6 | 6 | 6 | 8 | 10 | 10 | 10 | 10 | | 32 | 32 | 32 |
| 32 | 6 | 6 | 6 | 6 | 6 | 6 | 6 | 6 | 8 | 10 | 10 | 10 | 10 | | 34 | 34 | 34 |
| 34 | 6 | 6 | 6 | 6 | 6 | 6 | 6 | 6 | 8 | 10 | 10 | 10 | 10 | | 36 | 36 | 36 |
| 36 | 6 | 6 | 6 | 6 | 6 | 6 | 6 | 6 | 8 | 10 | 10 | 10 | 10 | | 38 | 38 | 38 |
| 38 | 6 | 6 | 6 | 6 | 6 | 6 | 6 | 6 | 8 | 10 | 10 | 10 | 10 | | 40 | 40 | 40 |
| 40 | 6 | 6 | 6 | 6 | 6 | 6 | 6 | 6 | 8 | 10 | 10 | 10 | 10 | | 42 | 42 | 42 |
| 42 | 6 | 6 | 6 | 6 | 6 | 6 | 6 | 6 | 8 | 10 | 10 | 10 | 10 | | | | |

Construction of Titan Vertical Engines

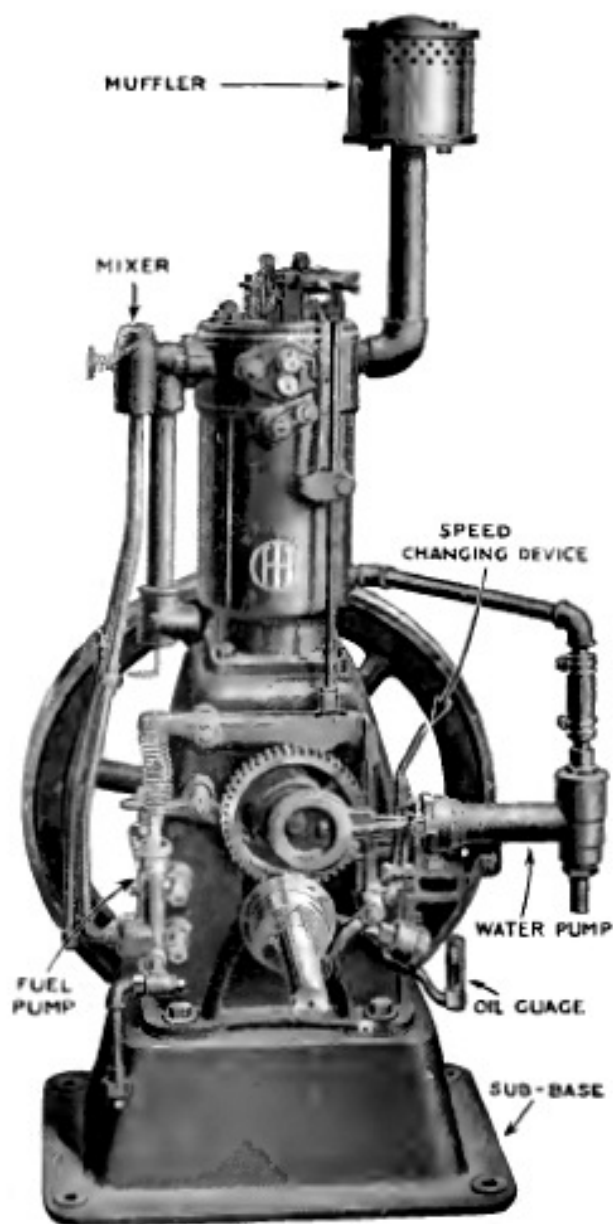

Side View of a Titan Vertical Engine with Flywheel Removed, Equipped with Circulating Pump and Speed Regulator

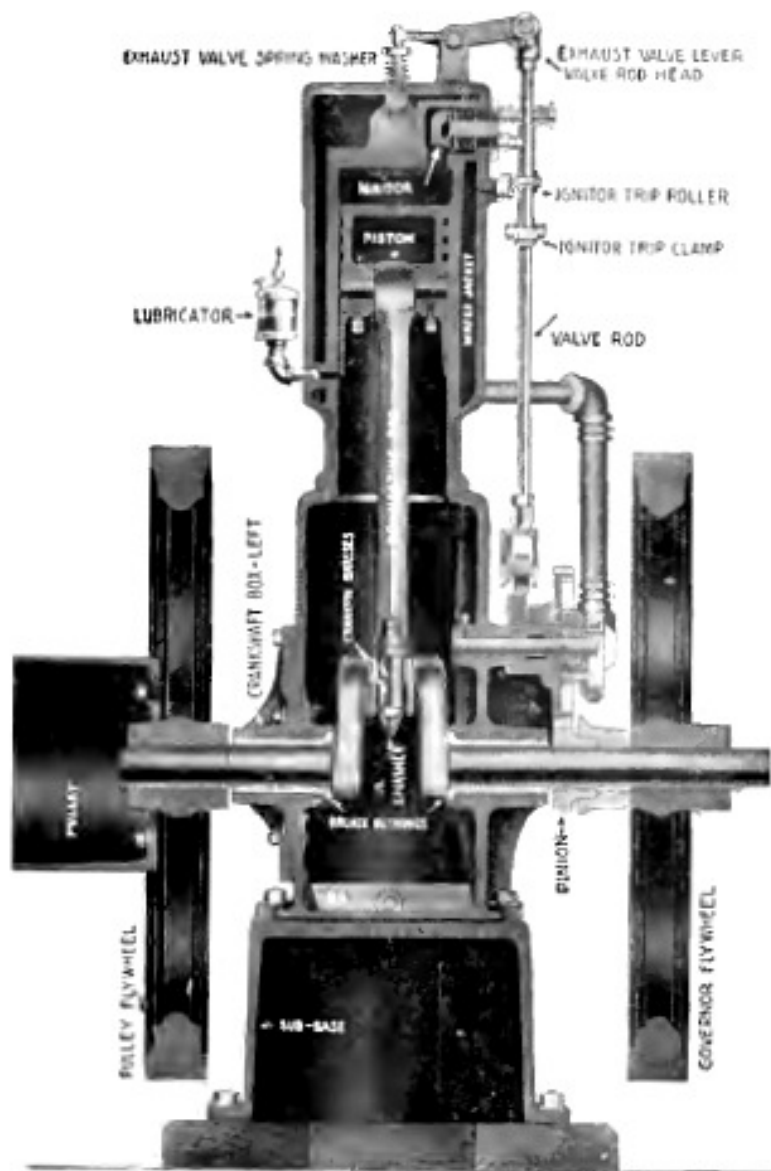

Sectional View of a Titan Vertical Engine, Showing Working Parts

A remarkably simple and efficient design has been attained in this engine.

The working parts are all conveniently located in full view on the governor side, so that this engine may be operated, cleaned, or oiled from one side. All parts are numbered and interchangeable, and can be easily removed. The crank case is enclosed and effectually protects the piston from dust and dirt and forms an oil receptacle for lubricating the connecting rod by the splash system. An oil

gauge on one side shows the oil-level in the base, and enables the operator to keep the oil at the proper depth.

The cylinder base and sub-base are cast separately. The base carries the cylinder and all the working parts. The sub-base furnishes a rigid support for the engine—and on the skidded engine forms a receptacle for the gasoline tank and protects it from injury. On the Titan engine, used for stationary work, it can be securely bolted to a solid foundation.

Connecting Rod—The connecting rod is a Steel Drop Forging of the I-section type. This style of construction gives the greatest strength, with the least weight, and insures a connecting rod that is proof against buckling. Both the crank-pin and piston-pin bearings are of Phosphor Bronze, and easily adjustable.



Drop-forged Steel Connecting Rod

The crank-pin bearings are of the split box type, bolted to the connecting rod by two heavy bolts secured by lock nuts and cotter pins. The piston-pin bearing is a Split Bronze Bushing, held in place by a set screw. The wear is taken up by a bolt secured by a lock nut and cotter pin.

Crank Shaft—The crank shaft is a Single Steel Drop Forging without a weld, accurately machined to size and highly polished. Titan



Drop-forged Steel Crank Shaft

crank shafts are made with a liberal factor of safety and can be relied on to withstand any strain under which the engine could operate.

Crank-Shaft Bearings—The crank-shaft bearings are of Phosphor Bronze, the best anti-friction metal known, and made extra thick and long. They fit snugly into the



Phosphor Bronze Crank-Shaft Bushings

engine base and are held tightly in place by set screws. They are first machined to size, then Hand Scraped to a perfect fit. This makes the best anti-friction bearing that it is possible to put in an engine. Each bushing is lubricated by a grease cup which is piped out within easy reach.

Flywheels—The flywheels are made large in diameter, with Split Hubs. Both clamped and keyed to the crank shaft so that it is practically impossible for them to become loose, though they may be easily removed if necessary. The pulley is bolted on one fly-wheel, the governor on the other.

Valve Gear—The valve gear is very simple and effective. It operates in a straight line and without requiring any fine adjustments. The valve rod, because of the construction of the cam upon which the cam roller turns, Serves the Double Purpose of Snapping the Ignitor and Opening the Exhaust Valve. This reduces the number of parts.



Cylinder Head Showing Ignition Trip and Valve Gear

The valves are carefully ground into their seats. The heads are of large diameter which allow the gas to enter freely and exhaust from the cylinder.

The inlet-valve check prevents fuel from entering the cylinder during the period when the governor cuts out explosions. This Eliminates Waste of Fuel, and enables the governor to regulate the fuel in proportion to the load.

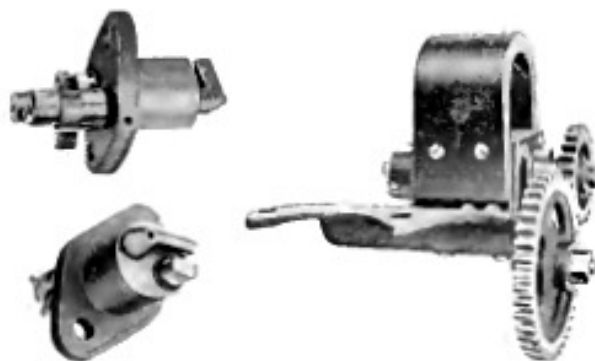

Side and End View of Ignitor

Magneto

Ignition—Ignition is make-and-break type, current being furnished by a gear driven magneto of the highest grade. No batteries are necessary with these engines as they can be readily started on the magneto. This eliminates great waste in the replacement of batteries.

Gasoline Mixer—The Titan vertical gasoline mixer is exceptionally simple and effective, and is one of the most economical features of Titan vertical engines. It has no troublesome float valve or complicated air valve to adjust. It Cannot Get Out of Order as the only movable part is the needle valve. The rapid rush of air through the air pipe sucks the gasoline into the air pipe in the form of a fine spray, which is almost immediately

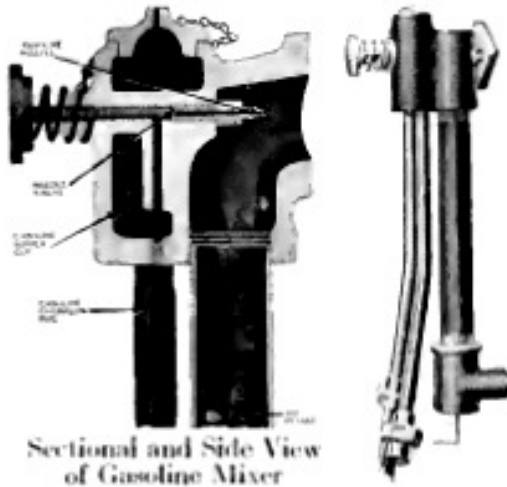

vaporized, and enters the cylinder thoroughly mixed with the proper proportion of air. As it does not depend on the evaporation of the fuel, this type of mixer is Less Affected by Weather Conditions and starting in cold weather is therefore an easy matter. Any excess of gasoline pumped into the mixer is returned to the supply tank by a large overflow pipe at the bottom of the mixer.

Governor—The governor is of the hit-and-miss type and operates the same as on Titan horizontal engines. It is sensitive in



Speed-Changing Device and Governor (Flywheel Removed)

operation and holds the engine at a steady speed. The inlet-valve check is operated in connection with the governor so that No Fuel is Wasted when the Governor Cuts Out a Power Stroke. The governor parts are few in number and exceedingly simple.

The speed-changing device consists of a small quadrant and lever and a rod operating the detent arm on its shaft. By shifting this lever, the travel of the Governor is Varied Sufficiently to Give Speed Variation of About 20 Per Cent, so that the speed best adapted to the machine being driven can be secured while the engine is running.

Water Pump—A simple, plunger type water pump is used on Titan vertical engines; it is Operated from the Cam Shaft by an eccentric. This gives a slower speed to the

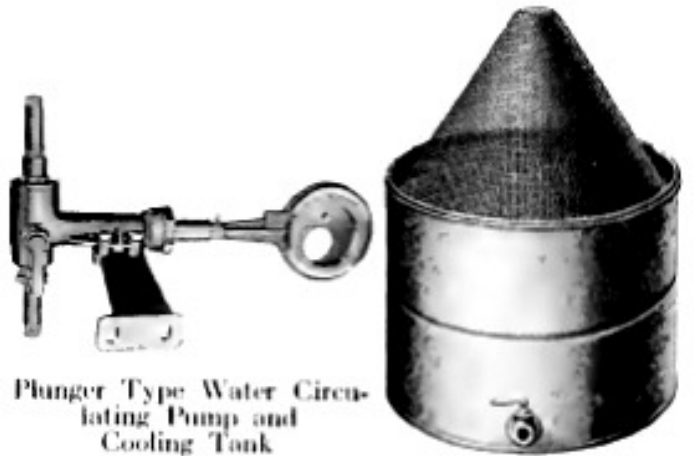

pump, which is most desirable when the engine is being run fast. It is Equipped with a Lever for Lifting the Valves from their Seats when it is necessary to drain the pump and water jacket. The Plunger and Valves are of Brass to prevent rusting.



Battery and Tool Box

Finish—The neat design and finish give Titan engines a very handsome appearance, though we do not believe in making our customers pay for unnecessary labor in this respect, as no amount of extra finish can increase the efficiency of an engine. They are attractively enameled in the standard ox blood red and Brewster green with gold striping.

Construction of Titan Engines 4 to 25-H. P.

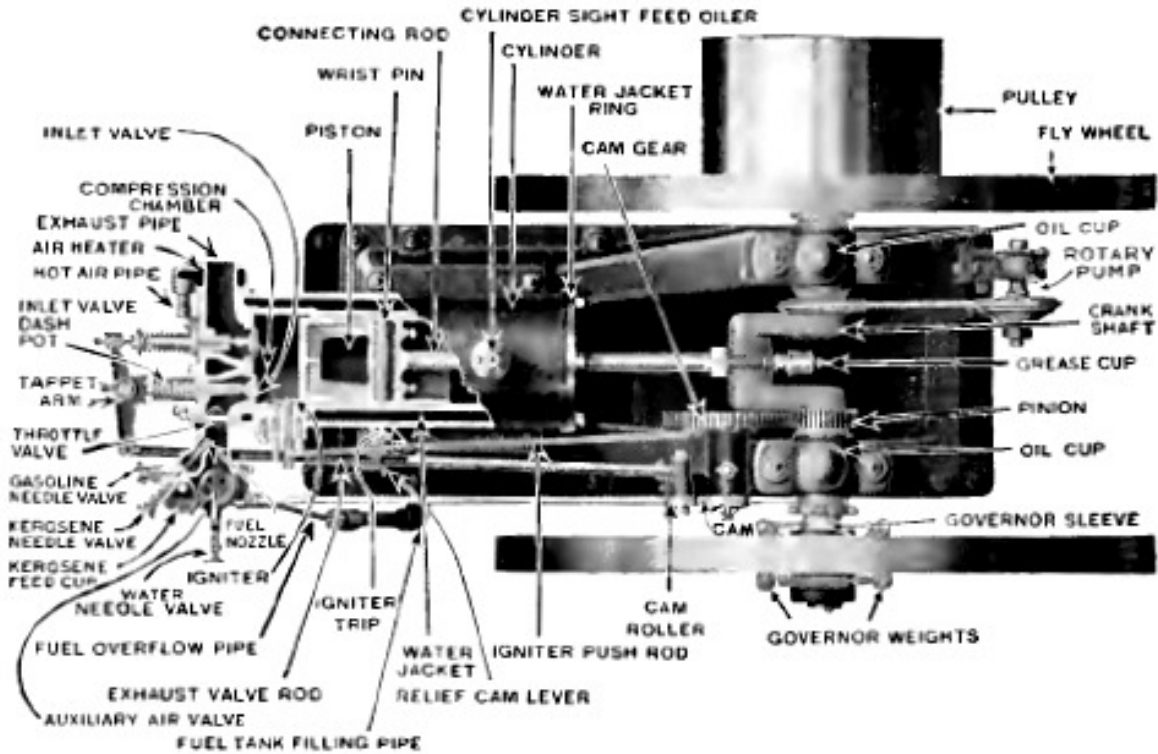

Top View of 1-H. P. Titan Tank-Cooled Oil Engine With Magneto Removed

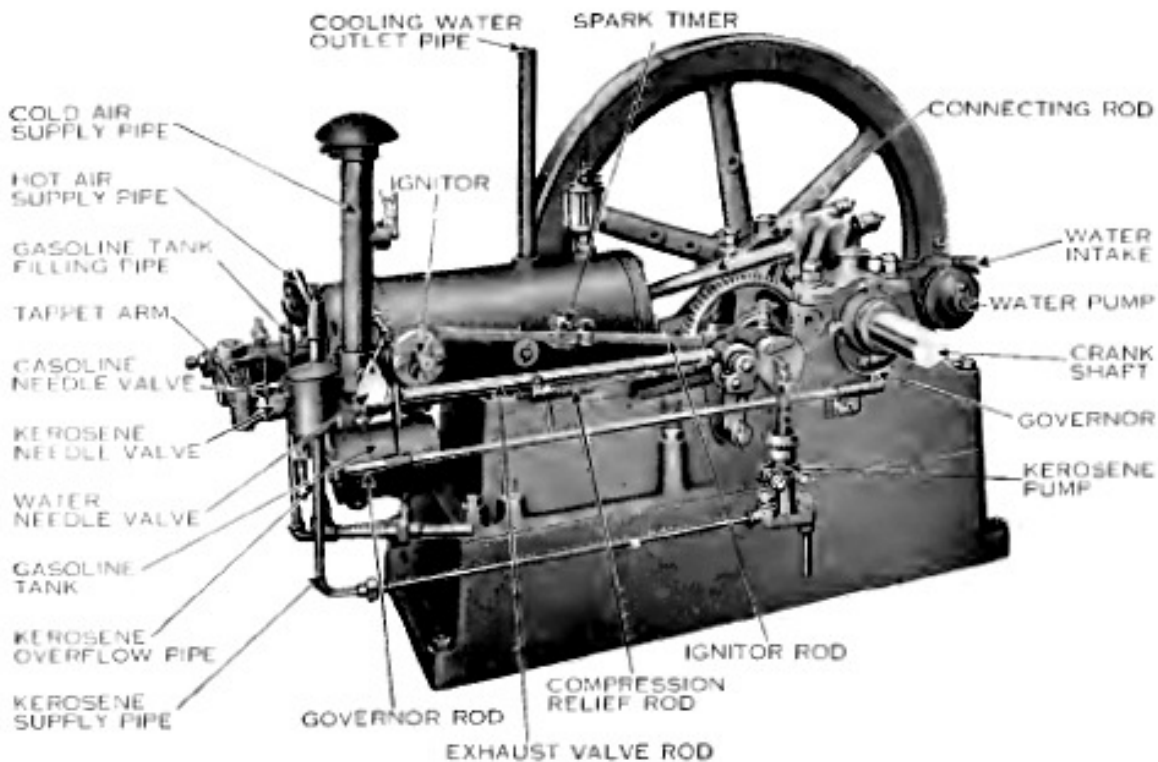

Side View of Titan 4-H. P. Oil Engine with Magneto and Flywheel Removed

Engine Frame—Manufacturing expense or cost of material have not been considered where a part could be improved or made more durable. The engine frame consists of two

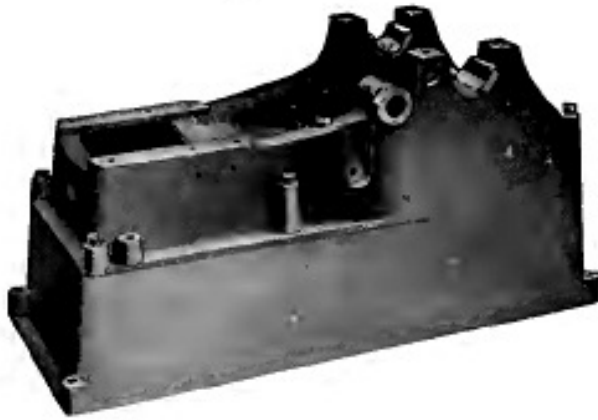

Engine Frame and Sub-base

main castings—base and sub-base. This method of construction is used to save unnecessary repairs and expense. The base carries all the working parts, while the sub-base forms a rigid support and can be securely bolted to a foundation when used for stationary work. The working parts, with the exception of the water pump, are all located on the right hand side, and are readily accessible for inspection or cleaning. All the Parts are Numbered and are Easily Removable, so that by giving these Numbers, Duplicate Parts, Guaranteed to Fit as Accurately as the Originals, can be Quickly Obtained.

Cylinder—The cylinder is cast from a special quality of close-grained grey iron. As

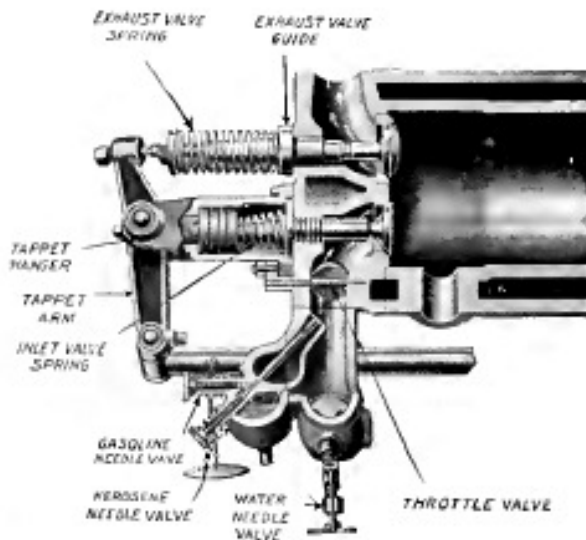

Section of Cylinder

the valves are set flush in the head, there are no valve pockets to absorb the heat and sap

the power. There are no projections other than the ignitor, which is designed to prevent heating. Provision is made for the cooling water to flow around the valve seats and parts in the head.

Piston—The piston is of the trunk type and extra long. The Wrist Pin is at the Center instead of at the end, so that the piston cannot wear to a taper. A supplemental piston pin oiler keeps the pin thoroughly oiled.



Piston and Lap-Joint Piston Rings

The piston pin is held securely in place by two set-screws with lock nuts. Instead of the customary three piston rings, these engines are equipped with four rings made with lap joints to hold the compression more perfectly.

Connecting Rod—The connecting rod is of drop-forged steel, carefully machined and polished. The crank pin box on the smaller sizes is of Phosphor Bronze; large sizes,

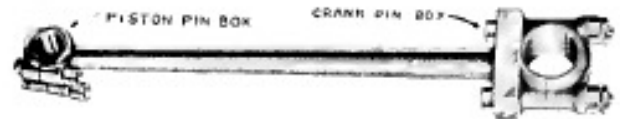

Horizontal Engine Connecting Rod

Babbitt with insertion of Graphite Lubricator. The piston pin bearing is provided with a Phosphor Bronze Bushing and can be easily adjusted to take up the wear.

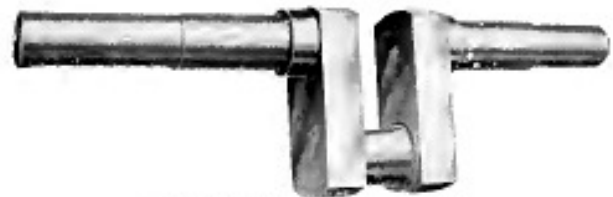

Polished Steel Crank Shaft

Crank Shaft—Titan crank shafts are all forged from One Piece of Steel Without Welds of any Kind. The crank pins are of large diameter, which gives a generous bearing surface for the connecting rod.



Titan Split Hub Flywheel

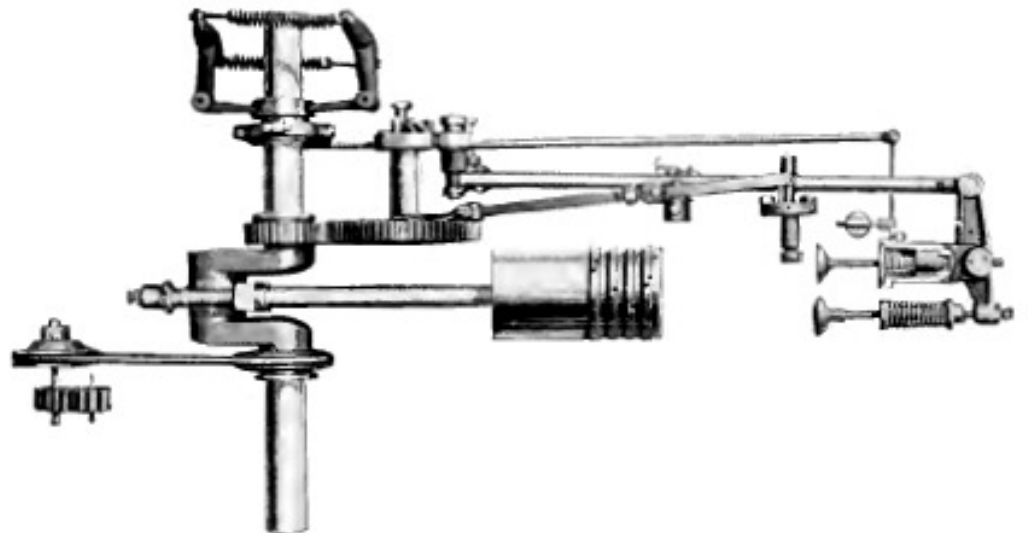

Working Parts of Titan Horizontal Engine, without Magneto

Crank-Shaft Bearings—The crank-shaft bearings are made of the best anti-friction metal and can be easily adjusted to take up wear.

These bearings are extra heavy and long, machine finished and Hand-Scraped to a perfect fit. They are of large diameter, thoroughly lubricated by oil cups of ample capacity. They are set into the main frame in such a manner that the strain is carried by the heavy engine frame and not on the cap bolts.

Flywheels—The flywheels are of the Split Hub Type, made large in diameter and heavy, and are both keyed and locked to the crank shaft by the compression bolts in the hub, so there is no danger of their becoming loose, yet they can be easily removed if necessary. Provision is made for attaching a belt pulley on either or both wheels.

Valves—The exhaust valve is mechanically operated. The stem is steel with the head cast on, making a one-piece valve of the highest wearing qualities. The head is large in area so that the gases are quickly exhausted from the cylinder when the valve is opened.

Inlet Valve—A special new feature on these engines is the improved inlet valve, which prevents the valve vibrating and pounding on the seat during the suction stroke.

The valve stem is supplied with a plunger or piston which operates in a small cylinder equipped with a pet cock for regulating the air cushion. When the valve opens, the plunger creates a suction behind it so that the valve closes tight without chattering on the

seat when the suction in the engine cylinder ceases and allows the valve to close.

Valve Mechanism—The valve mechanism is very simple and operates in a straight line. There are no delicate or complicated connections to get out of adjustment.

The cam for the ignitor eccentric is cast on the large gear. This gear is made with a split hub and is both keyed and bolted to the shaft and provided with a locking ring which slips over the end of the shaft.

Oil Mixer—This mixer is especially designed and constructed to operate on the lower grade fuels. It is very Simple in Design and can be Relied on Under all Conditions of Weather or Fuel. It is designed to operate on kerosene, distillate, gas oil or solar oil, but Will Handle Any of the Higher Grade Fuels Such as Gasoline, Motor Spirit or Naphtha Equally Well. It consists of a small gasoline

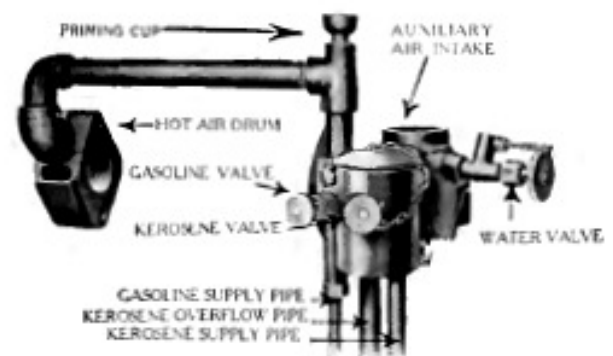

Titan Oil Mixer

tank and needle valve for starting and a kerosene tank, pump, needle valve, and water valve. The operation is as follows: The

engine is started on gasoline and, when warmed up, the kerosene is gradually turned on and the gasoline off. The water needle valve is then opened, giving better combustion and preventing pre-ignition.

Ignitor—The ignitor electrodes are made from steel, and the Ignition Points are Made from a Special Metal that will withstand the heat of the spark, as well as the effects of corrosion and oxidation.



End and Side View of Ignitor

The ignitor is directly in the path of entering charges, which aids in keeping the ignitor points clean and cool, besides brushing off any soot that may have been deposited upon them. By Removing Two Nuts the Ignitor Plug May be Easily Removed from the cylinder for inspection.

Ignitor Mechanism—The ignitor mechanism on Titan horizontal engines is extremely simple. The ignitor push rod is positive in its action and is operated by an eccentric on the half-speed gear. The contact points can be adjusted for early or late ignition by the adjustable sleeve on the push rod.

Governor—The throttling governor acts on a butterfly valve in the intake passage so that the fuel used is proportional to the load. The speed variation is very slight.

Starting Cam—Titan horizontal engines are equipped with a small auxiliary relief cam on the exhaust cam operated by a small lever

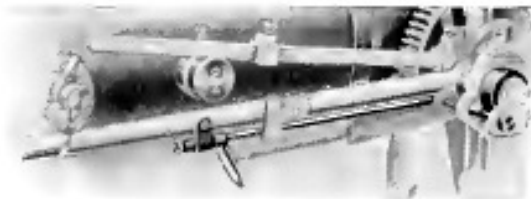

Compression Relief Cam

located on the exhaust push rod so that, in starting, the engine does not have to be turned against full compression.

Fuel Pump—The fuel pump is of the plunger type and Entirely Constructed of

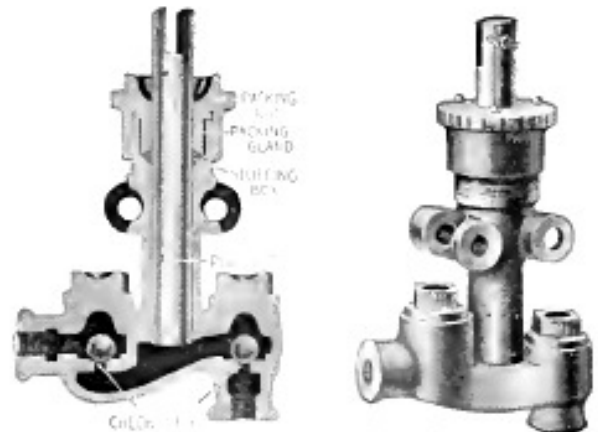

Sectional and Side View of Fuel Pump

Brass, Except the Plunger and Ball Valves which are of Steel. Only One Packing Gland is Used. This prevents fuel leaking past the plunger.



Rotary Pump Used on 4 and 6 H. P. Engines

Plunger Pump Used on Large Engines

Cooling—On the tank cooled type engines the cylinders are cooled by means of water circulated through the cylinder jackets and



Titan Tower Type Cooling Tank

through a screen type cooling tank. The cooling water is circulated on the 4 and 6 H. P. engines by a rotary pump, and on the larger

sizes by a plunger pump. On the hopper cooled type engines, the cylinder jackets are enlarged to form a large hopper open at the top. This hopper holds a sufficient quantity of water for cooling and no circulating pump or tank is necessary. This makes a very

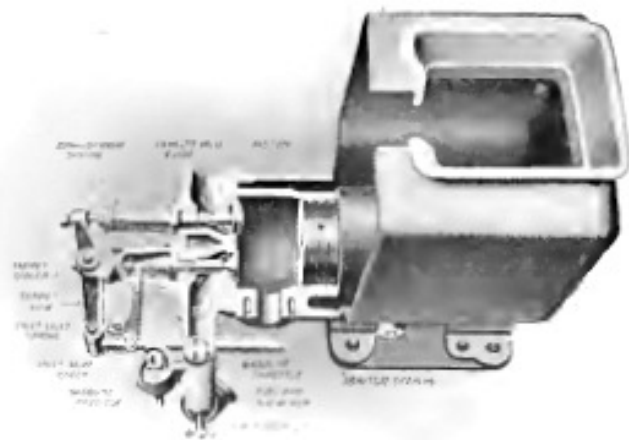

Sectional View of Hopper-Cooled Oil Engine Cylinder
 convenient method of cooling and is especially desirable in cold climates as there is no water piping or pump to freeze, and if by accident the water in the hopper becomes slightly frozen usually no injury results.

Electrical Equipment—All Titan engines are provided with Complete Electrical Equipment, including magneto (except portable engines which are equipped with batteries and auto sparker). The 4-H. P. size is equipped with a gear driven rotary magneto. Batteries and battery equipments are also furnished for starting. The 6-H. P. size and larger are



Dry Battery and Spark Coil

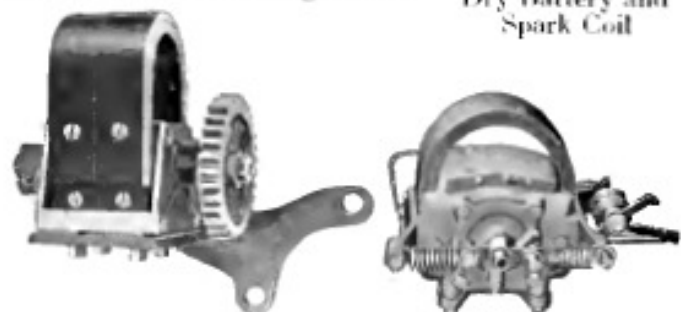

Magneto Used on 1-H. P. to 4-H. P. Horizontal and All Vertical Engines
 Magneto Used on 6-H.P. Horizontal Engine and Larger

equipped with an oscillating type magneto. No battery equipment is necessary as the engine can be started on the magneto.

Lubrication—Lubrication of Titan engines is provided for in a Very Thorough manner. The cylinder is lubricated by a large sight-feed oil cup placed on top of the cylinder. Oil cups of ample size lubricate the main bearings and



Titan Oil and Grease Cups

the cam shaft bearings. The crank-pin bearing is provided with a grease cup which gives ample lubrication yet prevents the throwing of oil which occurs when thin oil is used. The other minor bearings are provided with suitable oil holes.

Exhaust Mufflers—All stationary engines are equipped with a cast iron exhaust pot which effectively muffles the sound Without



Exhaust Pot, Large Muffler and Small Muffler

Causing Back Pressure. Other engines are equipped with mufflers which muffle the sound of the explosion and exhaust directly into the air.

Skids—All skidded engines are equipped with substantial hardwood skids, securely bolted together and nicely painted to match the engine. The skids are provided with iron shod runners and four iron rings, two on each end for hitching a horse to for hauling. The battery box is mounted on the tank end and provides a seat for the driver.

Finish—Titan engines present a very attractive appearance, both in design and finish. They are neatly finished in durable Brewster green and red enamel with gold striping. The machined parts are carefully polished, and the brass is machined and polished.

TITAN POWER FOR THE FARM

